

TravelMate 8471/8431 Series Service Guide

Service guide files and updates are available on the ACER/CSD web; for more information, please refer to <http://csd.acer.com.tw>

PRINTED IN TAIWAN

Revision History

Please refer to the table below for the updates made on TravelMate 8471/8431 service guide.

Date	Chapter	Updates

Copyright

Copyright © 2009 by Acer Incorporated. All rights reserved. No part of this publication may be reproduced, transmitted, transcribed, stored in a retrieval system, or translated into any language or computer language, in any form or by any means, electronic, mechanical, magnetic, optical, chemical, manual or otherwise, without the prior written permission of Acer Incorporated.

Disclaimer

The information in this guide is subject to change without notice.

Acer Incorporated makes no representations or warranties, either expressed or implied, with respect to the contents hereof and specifically disclaims any warranties of merchantability or fitness for any particular purpose. Any Acer Incorporated software described in this manual is sold or licensed "as is". Should the programs prove defective following their purchase, the buyer (and not Acer Incorporated, its distributor, or its dealer) assumes the entire cost of all necessary servicing, repair, and any incidental or consequential damages resulting from any defect in the software.

Acer is a registered trademark of Acer Corporation.

Intel is a registered trademark of Intel Corporation.

Pentium and Pentium II/III are trademarks of Intel Corporation.

Other brand and product names are trademarks and/or registered trademarks of their respective holders.

Conventions

The following conventions are used in this manual:

SCREEN MESSAGES	Denotes actual messages that appear on screen.
NOTE	Gives bits and pieces of additional information related to the current topic.
WARNING	Alerts you to any damage that might result from doing or not doing specific actions.
CAUTION	Gives precautionary measures to avoid possible hardware or software problems.
IMPORTANT	Reminds you to do specific actions relevant to the accomplishment of procedures.

Preface

Before using this information and the product it supports, please read the following general information.

1. This Service Guide provides you with all technical information relating to the BASIC CONFIGURATION decided for Acer's "global" product offering. To better fit local market requirements and enhance product competitiveness, your regional office MAY have decided to extend the functionality of a machine (e.g. add-on card, modem, or extra memory capability). These LOCALIZED FEATURES will NOT be covered in this generic service guide. In such cases, please contact your regional offices or the responsible personnel/channel to provide you with further technical details.
2. Please note WHEN ORDERING FRU PARTS, that you should check the most up-to-date information available on your regional web or channel. If, for whatever reason, a part number change is made, it will not be noted in the printed Service Guide. For ACER-AUTHORIZED SERVICE PROVIDERS, your Acer office may have a DIFFERENT part number code to those given in the FRU list of this printed Service Guide. You MUST use the list provided by your regional Acer office to order FRU parts for repair and service of customer machines.

System Specifications	1
System Block Diagram	4
Board Layout	5
Top View	5
Bottom View	6
Your Acer Notebook tour	7
Top View	7
Closed Front View	9
Rear view	9
Left View	10
Right View	10
Base view	11
Touchpad Basics (with fingerprint reader)	12
Touchpad basics (with two-click buttons)	13
Using the Keyboard	14
Lock Keys and embedded numeric keypad*	14
Windows Keys	15
Hot Keys	16
Using the system utilities	17
Acer Backup Manager	19
Power management	20
Acer PowerSmart key	20
Acer eRecovery Management	20
Burn backup discs	21
Restore	21
Hardware Specifications and Configurations	23
BIOS Setup Utility	27
System Utilities	27
Invoking BIOS Setup	28
Information	28
Main	29
Security	31
Boot	34
Exit	35
BIOS Flash Utility	36
Machine Disassembly and Replacement	37
General Information	38
Before You Begin	38
Disassembly Procedure Flowchart	39
Main unit disassembly flow chart	39
LCM module disassembly flow chart	39
Removing the Battery Pack	40
Removing the HDD and RAM	41
Remove Keyboard	44
Remove FFC of main board and sub board	45
Remove Panel	48
Disassembling the External Module	50
Disassembling the HDD Module	50
Troubleshooting	51
System Check Procedures	52
External Diskette Drive Check	52

Table of Contents

External CD-ROM Drive Check	52
Keyboard or Auxiliary Input Device Check	52
Memory check	53
Power System Check	53
Touchpad Check	54
Power-On Self-Test (POST) Error Message	55
Index of Error Messages	56
InsydeH2O BIOS Beep Codes	59
Index of Symptom-to-FRU Error Message	63
Intermittent Problems	67
Undetermined Problems	68
Top View	69
Jumper and Connector Locations	69
Bottom View	70
FRU (Field Replaceable Unit) List	71
TravelMate 8471/8431 Exploded Diagram	72
TravelMate 8471/8431 FRU List	75

System Specifications

Features

Below is a brief summary of the computer's many features:

Operating system

- Genuine Windows Vista®*
- Genuine Windows® 7*

NOTE: Windows® Vista® Capable PCs come with Windows® XP installed, and can be upgraded to Windows® Vista®. For more information on Windows® Vista® and how to upgrade, go to: Microsoft.com/windowsvista.

Platform

- Intel® Core™2 Duo processor*
- Intel® Core™2 Solo processor*
- Intel® Celeron® mobile processor*
- Mobile Intel® GS45 Express Chipset
- Intel® Wireless WiFi Link 5100*
- Acer InviLink™ Nplify™ 802.11b/g/Draft-N*
- Acer InviLink™ 802.11b/g*

System memory

- Dual-Channel SDRAM support
- Up to 2 GB of DDR3 1066 MHz memory, upgradeable to 4 GB using two soDIMM modules*
- Up to 4 GB of DDR3 1066 MHz memory, upgradeable to 8 GB using two soDIMM modules*

Display

- 16:9 aspect ratio
- 14.0" HD 1366 x 768

Graphics

- Mobile Intel® GS45 Express Chipset*
- ATI Mobility Radeon™ HD 4330*

Audio

- High-definition audio support
- MS-Sound compatible
- Built-in microphones

Storage subsystem

- 2.5" hard disk drive*
- 2.5" solid state drive*
- DVD-Super Multi double-layer drive
- Multi-in-1 card reader

Communication

- Integrated Acer Crystal Eye webcam*
- WLAN:
 - Intel® Wireless WiFi Link 5100*
 - Acer InviLink™ Nplify™ 802.11b/g/Draft-N*
 - Acer InviLink™ 802.11b/g*
- WPAN: Bluetooth® 2.1+Enhanced Data Rate (EDR)*
- WWAN: UMTS/HSPA at 850/900/1900/2100 MHz and quad-band GSM/GPRS/EDGE (850/900/1800/1900 MHz)*
- LAN: Gigabit Ethernet; Wake-on-LAN ready

Privacy control

- Enhanced Acer DASP (Disk Anti-Shock Protection)
- Acer Bio-Protection fingerprint solution*
- BIOS user, supervisor, HDD passwords
- Kensington lock slot

Dimensions and weight

- 314.9 (W) x 235 (D) x 25.9/29.6 (H) mm
(13.46 x 9.25 x 1.01/1.16 inches)
- 1.98 kg (4.37 lbs.) with 6-cell battery pack

Power subsystem

- ACPI 3.0
- 62.16W 5600 mAh*
- 3-pin 65W AC adapter
- ENERGY STAR®*

Special keys and controls

- 88-/89-/93- key keyboard
- Touchpad pointing device

I/O Ports

- Acer EasyPort IV connector
- Acer Bio-Protection fingerprint reader*
- Multi-in-1 card reader (SD/MMC/MS/MS PRO/xD)
- USB 2.0 port
- External display (VGA) port
- Headphones/speaker/line-out

-
- ❑ Microphone-in jack
 - ❑ Ethernet (RJ-45) port
 - ❑ DC-in jack for AC adapter

Environment

- ❑ Temperature:
 - operating: 5°C to 35°C
 - Non-operating: -20°C to 65°C
- ❑ Humidity (non-condensing):
 - operating: 20% to 80%
 - Non-operating: 20% to 80%

NOTE: "*" only for certain models.

NOTE: The specifications listed above are for reference only. The exact configuration of your PC depends on the model purchased.

System Block Diagram

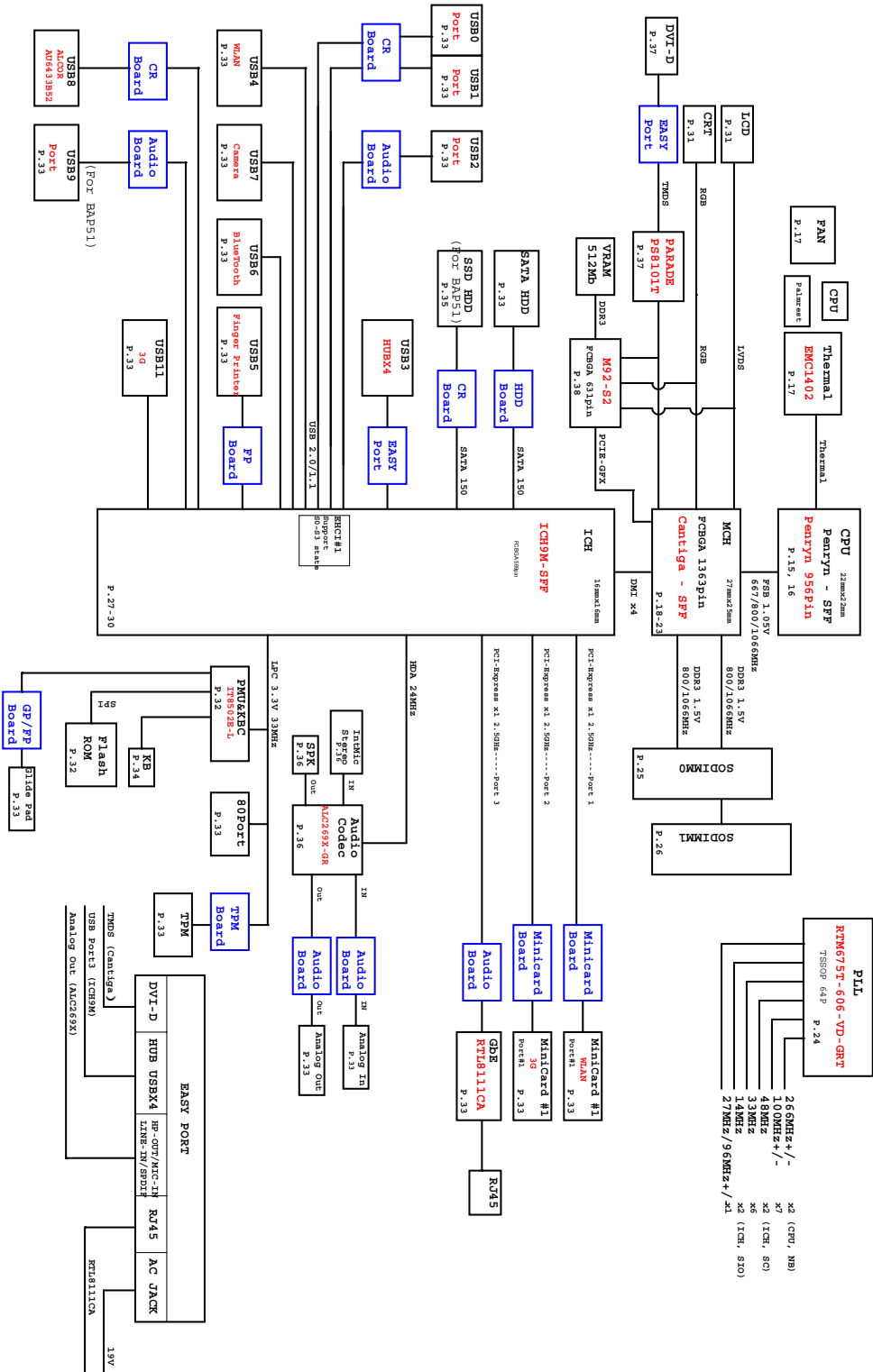

Board Layout

Top View

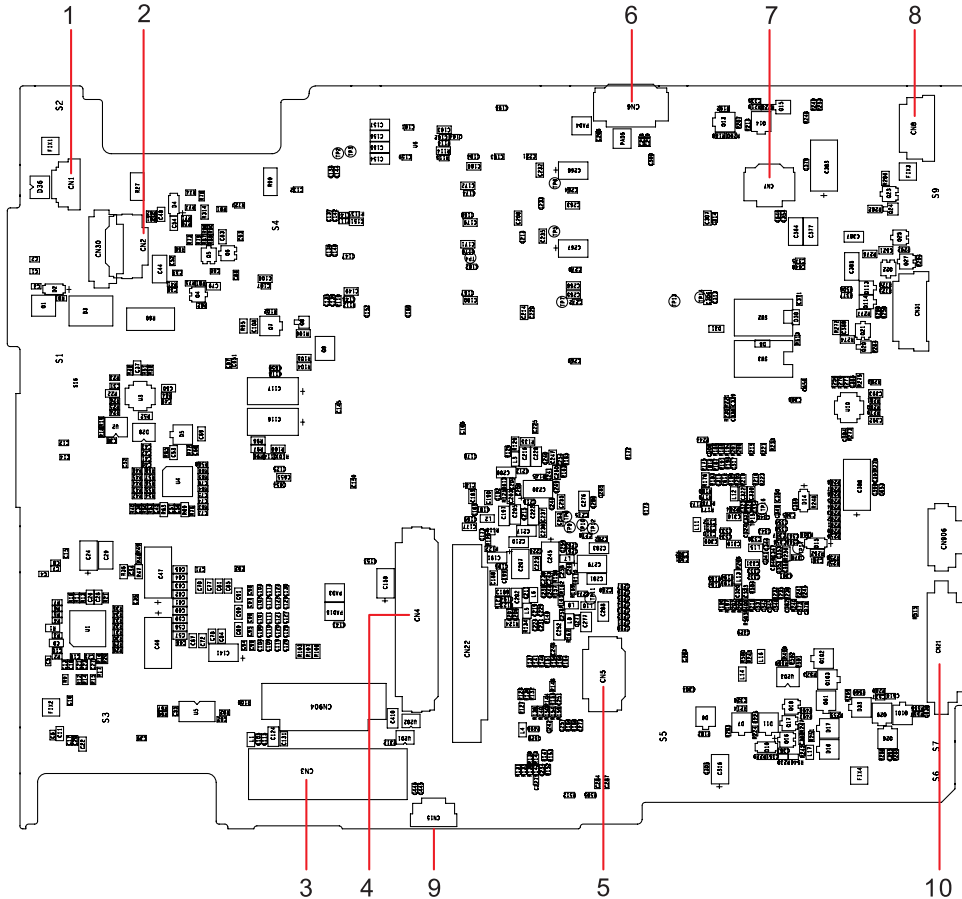

TravelMate 8471/8431 M/B layout and connector location TOP view		
No.	Name	Description
1	CN1	CCD cable CNTR
2	CN2	MMB cable CNTR
3	CN3	LVDS cable CNTR
4	CN4	Keyboard CNTR
5	CN5	Touch Pad FFC CNTR
6	CN6	SSD cable CNTR
7	CN7	Card reader CNTR
8	CN8	BT cable CNTR
9	CN15	Fan cable CNTR
10	CN21	Audio board CNTR

Bottom View

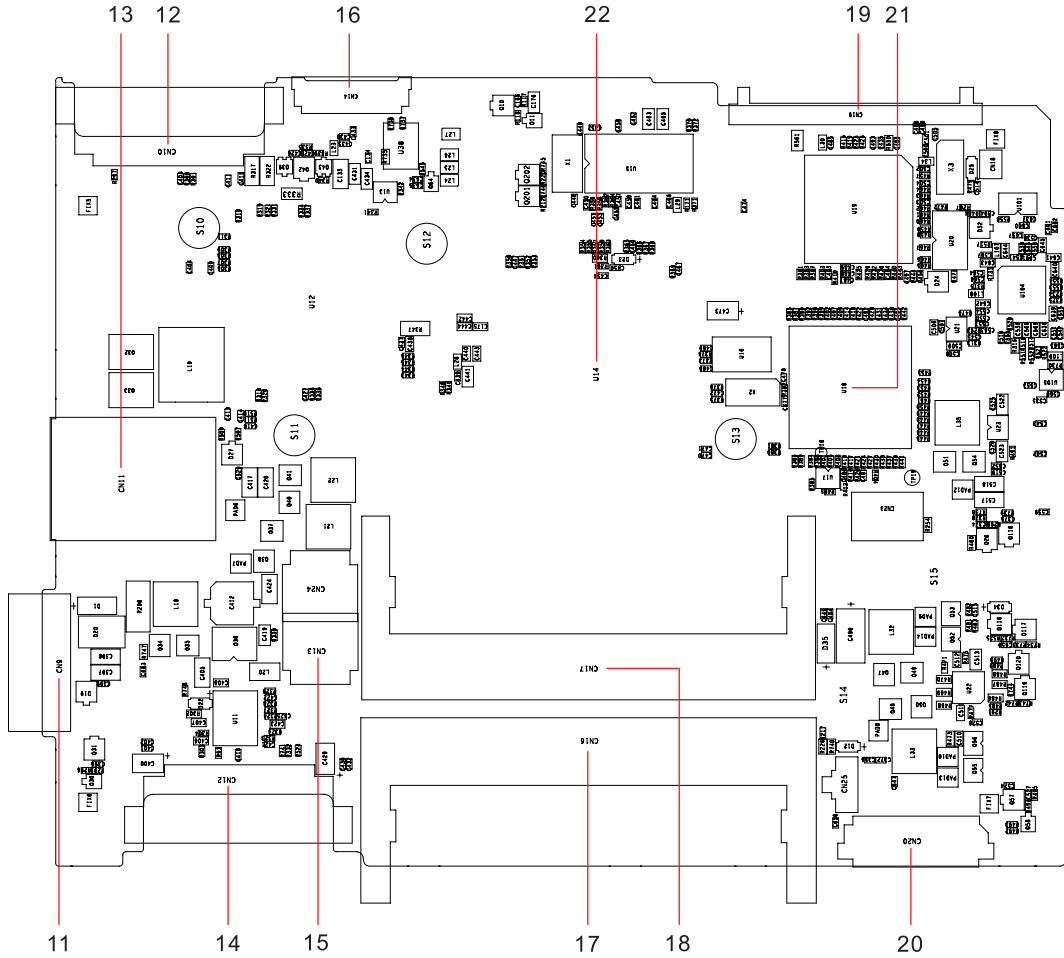

Bottom view		
No.	Name	Description
11	CN9	Battery CNTR
12	CN10	PCI-E socket
13	CN11	SIM card socket
14	CN12	PCI-E socket
15	CN13	Power cable CNTR
16	CN14	LVDS cable CNTR
17	CN16	DIMM socket
18	CN17	DIMM socket
19	CN19	HDD socket
20	CN20	USB board CNTR
21	U18	South Bridge
22	U14	North Bridge







Your Acer Notebook tour

After setting up your computer as illustrated in the Just for Starters... poster, let us show you around your new Acer notebook.

Top View



No.	Icon	Item	Description
1		Acer Crystal Eye webcam	Web camera for video communication.
2		Microphone	Internal microphone for sound recording.
3		Display screen	Also called Liquid-Crystal Display (LCD), displays computer output (Configuration may vary by models).
4		Speakers	Left and right speakers deliver stereo audio output.
5		Keyboard	For entering data into your computer.
6		Touchpad	Touch-sensitive pointing device which functions like a computer mouse.

No.	Icon	Item	Description
7		Click buttons (left, center* and right)	The left and right buttons function like the left and right mouse buttons. *The center button serves as Acer Bio-Protection fingerprint reader supporting Acer FingerNav 4-way control function (only for certain models).
8		Palmrest	Comfortable support area for your hands when you use the computer.
9		Touchpad toggle	Turns the internal touchpad on and off.
10		Eject Button	Presses to eject the optical disk from the drive.
		Optical disk access indicator	Lights up when the optical drive is active.
11		HDD	Indicates when the hard disk drive is active.
		Num Lock	Lights up when Num Lock is activated.
		Caps Lock	Lights up when Caps Lock is activated.
		Communication key	Enables / disables the WLAN / 3G functions.
		Backup key	Launches Acer Backup Management for three-step data backup.
		Acer PowerSmart key	Puts your computer into power-saving mode.
12		Power button / indicator	Turns the computer on and off. / Indicates the computer's power status.

Closed Front View

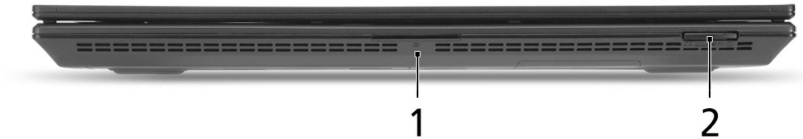

No.	Icon	Item	Description
1		Battery	Indicates the computer's battery status. 1. Charging: The light shows amber when the battery is charging. 2. Fully charged: The light shows blue when in AC mode.
2		Multi-in-1 card reader	Accepts Secure Digital (SD), MultiMediaCard (MMC), Memory Stick (MS), Memory Stick PRO (MS PRO), xD-Picture Card (xD). NOTE: Push to remove/install the card. Only one card can operate at any given time.



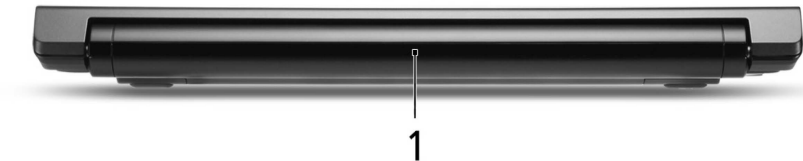



Rear view

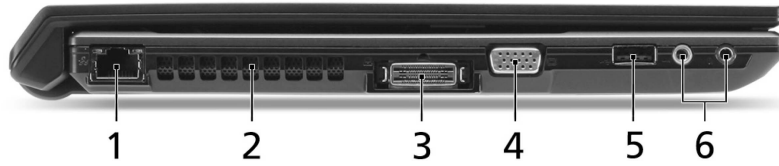

No.	Icon	Item	Description
1		Battery bay	Houses the computer's battery pack.



Left View



No.	Icon	Item	Description
1		Ethernet (RJ-45) port	Connects to an Ethernet 10/100/1000- based network.
2		Ventilation slots	Enable the computer to stay cool, even after prolonged use.
3		Acer EasyPort IV connector	Connects to Acer EasyPort IV.
4		External display (VGA) port	Connects to a display device (e.g., external monitor, LCD projector).
5		USB 2.0 ports	Connect to USB 2.0 devices (e.g., USB mouse, USB camera).
6		Microphone-in jack	Accepts inputs from external microphones.
		Headphones/ speaker/line-out jack	Connects to audio line-out devices (e.g., speakers, headphones).

Right View





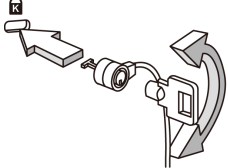

No.	Icon	Item	Description
1		USB 2.0 port	Connects to USB 2.0 devices (e.g., USB mouse, USB camera).
2		Optical driver	Internal optical drive; accepts CDs or DVDs.
3		Emergency eject hole	Ejects the optical drive tray when the computer is turned off. NOTE: Insert a paper clip to the emergency eject hole to eject the optical drive tray when the computer is off.
4		DC-in jack	Connects to an AC adapter.

No.	Icon	Item	Description
5		Kensington lock slot 	Connects to a Kensington-compatible computer security lock. NOTE: Wrap the computer security lock cable around an immovable object such as a table or handle of a locked drawer. Insert the lock into the notch and turn the key to secure the lock. Some keyless models are also available.

Base view



No.	Icon	Item	Description
1		Battery bay	Houses the computer's battery pack.
2		Battery lock	Locks the battery in position.
3		Memory compartment	Houses the computer's main memory.
4		Hard disk bay	Houses the computer's hard disk (secured with screws).
5		Ventilation slots and cooling fan	Enable the computer to stay cool, even after prolonged use. NOTE: Do not cover or obstruct the opening of the fan.
6		Battery release latch	Releases the battery for removal.

Touchpad Basics (with fingerprint reader)

The following items show you how to use the touchpad with Acer Bio-Protection fingerprint reader.

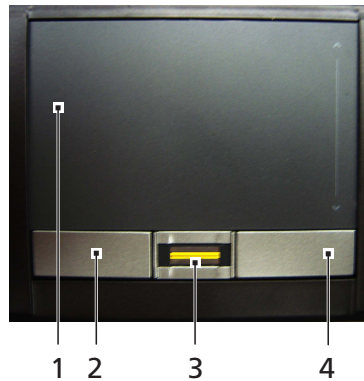

- ❑ Move your finger across the touchpad (1) to move the cursor.
- ❑ Press the left (2) and right (4) buttons located beneath the touchpad to perform selection and execution functions. These two buttons are similar to the left and right buttons on a mouse. Tapping on the touchpad is the same as clicking the left button.
- ❑ Use Acer Bio-Protection fingerprint reader (3) supporting Acer FingerNav 4-way control function (only for certain models) to scroll up or down and move left or right a page. This fingerprint reader or button mimics your cursor pressing on the right scroll bar of Windows applications.

Function	Left Button (2)	Right Button (4)	Main touchpad (1)	Center button (3)
Execute	Quickly click twice.		Tap twice (at the same speed as double-clicking a mouse button).	
Select	Click once.		Tap once.	
Drag	Click and hold, then use finger on the touchpad to drag the cursor.		Tap twice (at the same speed as double-clicking a mouse button); rest your finger on the touchpad on the second tap and drag the cursor.	
Access context menu		Click once.		
Scroll				Swipe up/down/left/right using Acer FingerNav 4-way control function(Manufacturing option).

Touchpad basics (with two-click buttons)

The following items show you how to use the touchpad with two-click buttons.

- ❑ Move your finger across the touchpad to move the cursor.
- ❑ Press the left and right buttons located beneath the touchpad to perform selection and execution functions. These two buttons are similar to the left and right buttons on a mouse. Tapping on the touchpad is the same as clicking the left button.

Function	Left Button	Right Button	Main touchpad
Execute	Quickly click twice.		Tap twice (at the same speed as double-clicking a mouse button).
Select	Click once.		Tap once.
Drag	Click and hold, then use finger on the touchpad to drag the cursor.		Tap twice (at the same speed as double-clicking a mouse button); rest your finger on the touchpad on the second tap and drag the cursor.
Access context menu		Click once.	

NOTE: Illustrations for reference only. The exact configuration of your PC depends on the model purchased.

NOTE: When using the touchpad, keep it — and your fingers — dry and clean. The touchpad is sensitive to finger movement; hence, the lighter the touch, the better the response. Tapping harder will not increase the touchpad's responsiveness.

NOTE: By default, vertical and horizontal scrolling is enabled on your touchpad. It can be disabled under Mouse settings in Windows Control Panel.

Using the Keyboard

The keyboard has full-sized keys and an embedded numeric keypad*, separate cursor, lock, Windows, function and special keys.

Lock Keys and embedded numeric keypad*

The keyboard has three lock keys which you can toggle on and off.



Lock key	Description
Caps Lock	When Caps Lock is on, all alphabetic characters typed are in uppercase.
Num Lock <Fn> + <F11>*	When Num Lock is on, the embedded keypad is in numeric mode. The keys function as a calculator (complete with the arithmetic operators +, -, *, and /). Use this mode when you need to do a lot of numeric data entry. A better solution would be to connect an external keypad.
Scroll Lock <Fn> + <F12>	When Scroll Lock is on, the screen moves one line up or down when you press the up or down arrow keys respectively. Scroll Lock does not work with some applications.



















The embedded numeric keypad functions like a desktop numeric keypad. It is indicated by small characters located on the upper right corner of the keycaps. To simplify the keyboard legend, cursor-control key symbols are not printed on the keys.

Desired access	Num Lock on	Num Lock off
Number keys on embedded keypad	Type numbers in a normal manner.	
Cursor-control keys on embedded keypad	Hold <Shift> while using cursor-control keys.	Hold <Fn> while using cursor-control keys.
Main keyboard keys	Hold <Fn> while typing letters on embedded keypad.	Type the letters in a normal manner.

* only for certain models

Windows Keys

The keyboard has two keys that perform Windows-specific functions.

Key	Description
Windows key 	<p>Pressed alone, this key has the same effect as clicking on the Windows Start button; it launches the Start menu. It can also be used with other keys to provide a variety of functions:</p> <ul style="list-style-type: none"> <  > : Open or close the Start menu. <  > + <D>: Display the desktop. <  > + <E>: Open Windows Explore. <  > + <F>: Search for a file or folder. <  > + <G>: Cycle through Sidebar gadgets. <  > + <L>: Lock your computer (if you are connected to a network domain), or switch users (if you're not connected to a network domain). <  > + <M>: Minimizes all windows. <  > + <R>: Open the Run dialog box. <  > + <T>: Cycle through programs on the taskbar. <  > + <U>: Open Ease of Access Center. <  > + <X>: Open Windows Mobility Center. <  > + <BREAK>: Display the System Properties dialog box. <  > + <SHIFT+M>: Restore minimized windows to the desktop. <  > + <TAB>: Cycle through programs on the taskbar by using Windows Flip 3-D. <  > + <SPACEBAR>: Bring all gadgets to the front and select Windows Sidebar. <CTRL> + <  > + <F>: Search for computers (if you are on a network). <CTRL> + <  > + <TAB>: Use the arrow keys to cycle through programs on the taskbar by using Windows Flip 3-D. <p>NOTE: Depending on your edition of Windows Vista, some shortcuts may not function as described.</p>
Application key 	<p>This key has the same effect as clicking the right mouse button; it opens the application's context menu.</p>

Hot Keys

The computer employs hotkeys or key combinations to access most of the computer's controls like screen brightness and volume output.

To activate hot keys, press and hold the <Fn> key before pressing the other key in the hotkey combination.



Hotkey	Icon	Function	Description
<Fn> + <F2>		System property	Starts System Property for displaying system information.
<Fn> + <F3>		Bluetooth	Enables/disables the Bluetooth function. (only for certain models).
<Fn> + <F4>		Sleep	Puts the computer in Sleep mode.
<Fn> + <F5>		Display toggle	Switches display output between the display screen, external monitor (if connected) and both.
<Fn> + <F6>		Screen blank	Turns the display screen backlight off to save power. Press any key to return.
<Fn> + <F8>		Speaker toggle	Turns the speakers on and off.
<Fn> + <▷>		Brightness up	Increases the screen brightness.
<Fn> + <◁>		Brightness down	Decreases the screen brightness.
<Fn> + <△>		Volume up	Increases the sound volume.
<Fn> + <▽>		Volume down	Decreases the sound volume.

Using the system utilities

Acer Bio-Protection (only for certain models)

Acer Bio-Protection Fingerprint Solution is a multi-purpose fingerprint software package integrated with the Microsoft Windows operating system. Utilizing the uniqueness of one's fingerprint, Acer Bio-Protection Fingerprint Solution incorporates protection against unauthorized access to your computer with centralized password management via Password Bank; easy music player launching with Acer MusicLaunch*; secure Internet favorites via Acer MyLaunch*; and fast application/website launching and login with Acer FingerLaunch. Acer ProfileLaunch** can launch up to three applications/ websites with a single finger swipe.

Acer Bio-Protection Fingerprint Solution also allows you to navigate through web browsers and documents using Acer FingerNav*. With Acer Bio-Protection Fingerprint Solution, you can now enjoy an extra layer of protection for your personal computer, as well as the convenience of accessing your daily tasks with a simple swipe of your finger!

For more information, refer to the Acer Bio-Protection help files.

NOTE:

* Acer ProfileLaunch, MusicLaunch, MyLaunch and FingerNav are only available on select models.

** In models without Acer ProfileLaunch, Acer FingerLaunch can be used to open applications in the Acer ProfileLaunch icons area; a single finger swipe will launch only one application at a time.

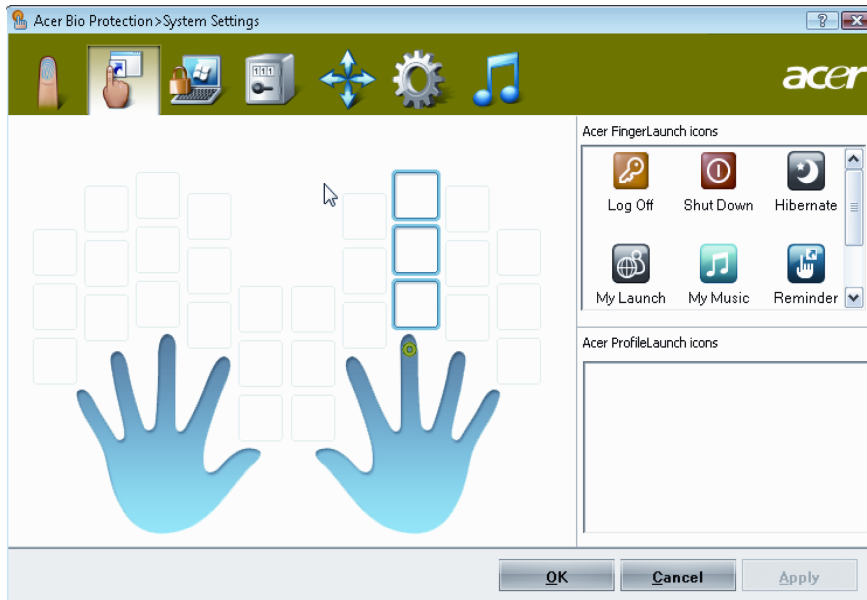

Acer GridVista (dual-display compatible)

NOTE: This feature is only available on certain models.

To enable the dual display feature of your notebook, first ensure that a second display is connected, then, open the Display Settings properties box using the Control Panel or by right-clicking the Windows desktop and selecting **Personalize**. Select the secondary monitor (**2**) icon in the display box and then click the check box **Extend the desktop onto this monitor**. Finally, click **Apply** to confirm the new settings and click **OK** to complete the process.

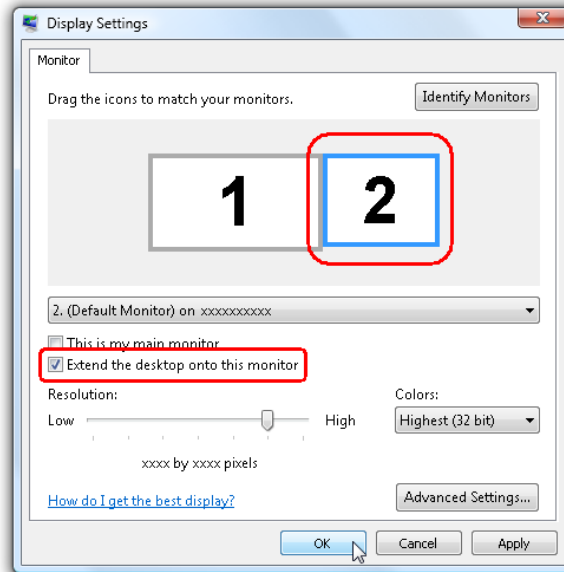

Acer GridVista is a handy utility that offers four pre-defined display settings so you can view multiple windows on the same screen. To access this function, please go to **Start, All Programs** and click on **Acer GridVista**. You may choose any one of the four display settings indicated below:

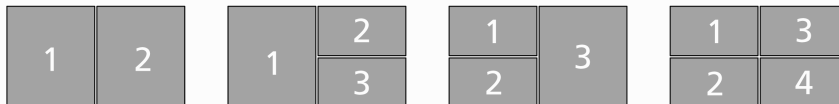

Double (vertical), Triple (primary at left), Triple (primary at right), or Quad.

Acer GridVista is dual-display compatible, allowing two displays to be partitioned independently.

Acer GridVista is simple to set up:

1. Run Acer GridVista and select your preferred screen configuration for each display from the taskbar.
2. Drag and drop each window into the appropriate grid.

3. Enjoy the convenience of a well-organized desktop.

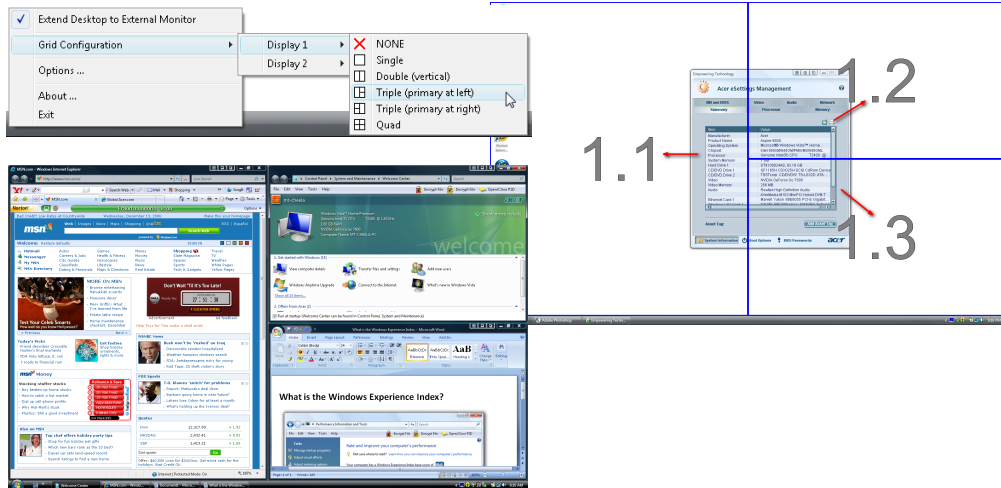

NOTE: Please ensure that the resolution setting of the second monitor is set to the manufacturer's recommended value.

Acer Backup Manager

NOTE: This feature is only available on certain models.

Acer Backup Manager is a simple three-step process that allows you to create backup copies of your entire system or selected files and folders according to a schedule or as you need to.

To start Acer Backup Manager, press the Acer Backup Manager key above the keyboard. Alternatively, you can go to **Start > All Programs > Acer Backup Manager > Acer Backup Manager**. This will open the Welcome screen; from this screen you will be taken through the three steps to setup scheduled backups.

Click **Continue** to proceed to the following screen. Click the + button and follow the onscreen instructions:

1. Select the content you want to back up. The less content you select, the quicker the process will be, but it will increase your risks of losing data.
2. Select where you want the backup copies to be stored. You will need to select an external drive or your D: drive; Acer Backup Manager cannot store a backup on the source drive.
3. Select how often you want Acer Backup Manager to create backups.

Once you have finished these three steps, backups will be created according to the schedule. You can also create backups manually by pressing the Acer Backup Manager key.

If you wish to change your settings at any time, run Acer Backup Manager from the **Start** menu and go through the steps outlined above.

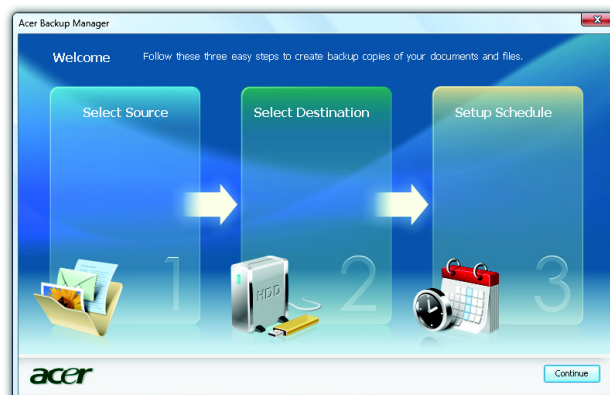

Power management

This computer has a built-in power management unit that monitors system activity. System activity refers to any activity involving one or more of the following devices: keyboard, mouse, hard disk, peripherals connected to the computer, and video memory. If no activity is detected for a period of time (called an inactivity timeout), the computer stops some or all of these devices in order to conserve energy.

This computer employs a power management scheme that supports the advanced configuration and power interface (ACPI), which allows for maximum power conservation and maximum performance at the same time. Windows handles all power-saving chores for your computer.

Acer PowerSmart key

The Acer PowerSmart key uses the power-saving features of your computer's graphics sub-system to reduce overall power consumption. When you press the Acer PowerSmart key, the screen brightness is reduced and the graphics chip switched to a lower speed; PCI and WLAN switch to power-saving modes. Press the Acer PowerSmart key again to return to your previous settings.

NOTE: This feature is only available on certain models.

Acer eRecovery Management

Acer eRecovery Management is a tool to quickly restore the system. You can back up/restore the factory default image, and reinstall applications and drivers.

NOTE: All of the following content is for general reference only. Actual product specifications may vary.

Acer eRecovery Management consists of the following functions:

1. Backup:
 - Create Factory Default Disc
 - Create Drivers and Applications Disc
2. Restore:
 - Completely Restore System to Factory Defaults
 - Restore Operating System and Retain User Data
 - Reinstall Drivers or Applications

This chapter will guide you through each process.

NOTE: This feature is only available on certain models. For systems that do not have a built-in optical disc burner, plug in an external optical disc burner before entering Acer eRecovery Management for optical disc-related tasks.

To use the password protection feature of Acer eRecovery Management, you must first set the password. The password is set by launching Acer eRecovery Management and clicking **Settings**.

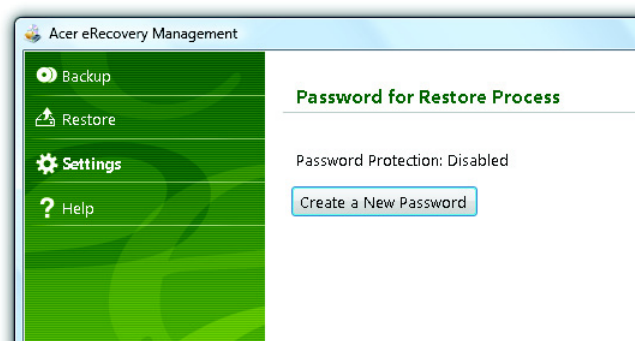

Burn backup discs

From the Backup page of Acer eRecovery Management, you can burn the factory default image or back up drivers and applications.

1. Click on **Start > All Programs > Acer > Acer eRecovery Management**.
2. Acer eRecovery Management opens to the **Backup** page.

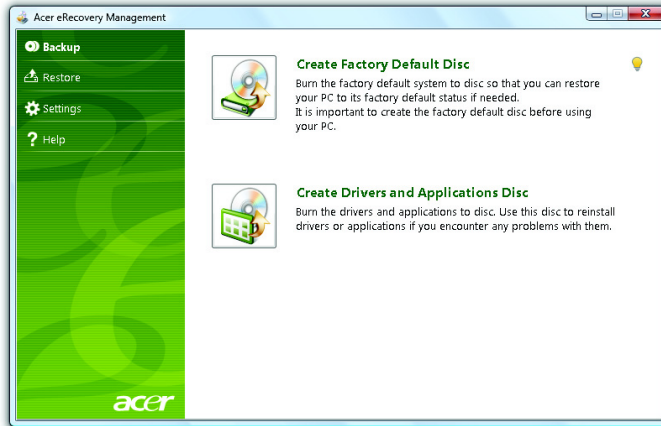

3. Select the type of backup (factory default or drivers and applications) you would like to burn to disc.
4. Follow the instructions on screen to complete the process.

NOTE: Create a factory default image when you want to burn a bootable disc that contains your computer's entire operating system as it was delivered to you from the factory. If you wish to have a disc that will allow you to browse the contents and install selected drivers and applications, create a drivers and application backup instead — this disc will not be bootable.

Restore

The restore feature allows you to restore or recover the system from a factory default image or from previously created CD and DVD backups. You can also reinstall applications and drivers for your Acer system.

1. Click on **Start, All Programs, Acer, Acer eRecovery Management**.
2. Switch to the **Restore** page by clicking **Restore**.



-
3. You can choose to restore the system from a factory default image or reinstall applications and drivers.
 4. Follow the instructions on screen to complete the process.

Restore Windows Vista from backup discs

To restore Windows Vista from your previously burned backup discs, you will need to insert the first backup disc and enable the **F12 Boot Menu** via the BIOS Setup Utility.

1. Turn on your computer and insert the first system recovery disc into the optical disc drive. Restart your computer.
2. During startup when the Acer logo shows, press the **F2** key to enter **BIOS Setup**, where you can set system parameters.
3. Use the left and right arrow keys to select the **Main** submenu.
4. Use the up and down arrow keys to select **F12 Boot Menu**.
5. Use the **F5** or **F6** key to change **F12 Boot Menu** to **Enabled**.
6. Press the **ESC** key to enter the **Exit** submenu, press the **ENTER** key to **Exit Saving Changes**. Press the **ENTER** key again to select **Yes**. The system will reboot.
7. After rebooting, when the Acer logo shows, press the **F12** key to open the **Boot Menu**. Here you can select which device to boot from.
8. Use the arrow keys to select the **IDE CD**, then press the **ENTER** key. Windows will be installed from the recovery disc.
9. Insert the second recovery disc when prompted, then follow the onscreen prompts to complete the restore.
10. Remove the recovery disc from the optical drive once the restore is complete. Do this before rebooting your computer.

If you prefer to set the boot priority for long-term use, you should select the **Boot** submenu.

1. Turn on your computer and insert the first system recovery disc into the optical disc drive. Restart your computer.
2. During startup when the Acer logo shows, press the **F2** key to enter **BIOS Setup**, where you can set system parameters.
3. Use the left and right arrow keys to select the **Boot** submenu.
4. Use the up and down arrow keys to select the **IDE CD** device.
5. Use the **F6** key to move the **IDE CD** device to the highest boot priority, or use the **F5** key to move other devices to a lower boot priority. Ensure that the **IDE CD** device is the highest priority.
6. Press the **ESC** key to enter the **Exit** submenu, press the **ENTER** key to **Exit Saving Changes**. Press the **ENTER** key again to select **Yes**. The system will reboot.
7. When you reboot, Windows will be installed from the recovery disc.
8. Insert the second recovery disc when prompted, then follow the onscreen prompts to complete the restore.
9. Remove the recovery disc from the optical drive once the restore is complete. Do this before rebooting your computer.

Hardware Specifications and Configurations

Processor

Item	Specification
Processor packing	uFCPGA
Support Processor @ Launch	ULV Centrino, PDC, ICPM
On-die L2 Cache	Up to 6 MB
FSB	1.4 G
TDP (Thermal)	10W
Socket type	BGA

Second Level Cache

Item	Specification
North Bridge	GS45
South Bridge	Intel ICH9M-SFF

System Memory

Item	Specification
Technology	DDR3 1066MHz
Base memory	DDR3 667 / 800 / 1066 MHz
Expansion memory	DDR3 667 / 800 / 1066 MHz
Maximum memory size	8 GB

Lan Interface

Item	Specification
Controller (AVAP)	RTL8111CA-VB-GR
SPEED	10 / 100 / 1000Mb/s

Wireless LAN

Item	Specification
Module	Intel 512AN_HWMG Shirley Peak
Interface	Mini Card
Antenna	2

Pointing Device

Item	Specification
Glide	TM-00450-008

Bluetooth Interface

Item	Specification
Module	FOX_BRM_2.0 F/W T60H928.11
Antenna	on board
controller	CSR
Bluetooth module	Internal USB 2.0 compliant interface

Hard Disk Drive Interface

Item	Specification
HDD form factor	9.5 mm high/ solid state disks
Media I/F	SATA
IDE Controller	SATA 150 MB/s
SSD Media size	320 GB (Option)
SSD form factor	2.5" factor

Audio Interface

Item	Specification
Sound Codec (AVAP)	Realtek ALC269
Internal Speakers	2 (1.5 Watt)
Internal Microphone	Array MIC x 1
Sound Volume	By Hot Key

LCD panel

Item	Specification
Panel size	14 WXGA None Glare B140XW02 V3 LF 200nit 8ms 500:1
LVDS	Embedded in Cantigate GM
Brightness	Brightness controlled by hotkey

Card Slot

Item	Specification
5 in 1 card reader (SD/MMC/MS/MSPro/xD)	Realtek Cardbus RTSS159-GR

WebCAM

Item	Specification
Module	Suyin 1.0M
Interface	USB

Keyboard

Item	Specification
Controller	Non-glossy JM31 KB
Type (AVAP)	Normal key 1.80 ± 0.2mm

I/O

Item	Specification
USB	3
Stereo Mic-in	1
SPDIF	1
RJ45 (Shielding)	1
mini card socket	Full mini card (3G) x 1 & Half mini card (SP WLAN) x 1

Button

Item	Specification
Power on/off	1 (mechanical, Blue/Orange Flash)
Launch key module(Follow spec)	None
Back up key	1 (mechanical, Blue)
Power consumption key	1 (mechanical, Green)
Volume Control	On KB

Software

Item	Specification
Operation system	Vista SP1/SP2, XP, Windows 7 (Ready)
BIOS	Insyde

Power Management

Item	Specification
Controller	ITE ITE8512F
Interface	LPC
AC adapter (AVAP)	65W
1st Battery (AVAP)	6 cell 2.6 / 2.8 / 2.9

LED Status Indicator

Item	Specification
1st Battery Status	1 (Blue/Orange)
HDD	1 (Blue / flash)
Caps Lock	1 (Blue)
Num Lock	1 (Blue)

Security Features

Item	Specification
TPM	1
Finger print	Optional
PBA	1

FAN

Item	Specification
Not Noise	as low as possible
Number	1

Physical Characteristics

Item	Specification
Dimensions	323.6 (W) x 228 (D) mm
Thickness (maximum)	23.3 ~ 27.9mm
Weight (incl 1st Battery & super multi ODD)	< 1.7 kg

System Utilities

BIOS Setup Utility

The BIOS Setup Utility is a hardware configuration program built into your computer's BIOS (Basic Input/Output System).

Your computer is already properly configured and optimized, and you do not need to run this utility. However, if you encounter configuration problems, you may need to run Setup. Please also refer to Chapter 4 Troubleshooting when problem arises.

To activate the BIOS Utility, press **m** during POST (when "Press <F2> to enter Setup" message is prompted on the bottom of screen).

Press **m** to enter setup. The default parameter of **F12** Boot Menu is set to "**disabled**". If you want to change boot device without entering BIOS Setup Utility, please set the parameter to "**enabled**".

Press <F12> during POST to enter multi-boot menu. In this menu, user can change boot device without entering BIOS SETUP Utility.

InsydeH2O Setup Utility				
Information	Main	Security	Boot	Exit
CPU Type:	Intel (R) Core CPU			Xxxx
CPU Speed:	XXXX GHz			
HDD0 Model Name:	Hitachi HTS545016B9A300			
HDD0 Serial Number:	090227PB0B00QNG07WZA			
HDD1 Model Name:	None			
HDD1 Serial Name:				
ATAPI Model Name:	None			
System BIOS Version:	VXXXX			
VGA BIOS Version:	Intel V1744			
Serial Number:	xxxxxxxxxxxxxxxxxxxx			
Asset Tag Number:	None			
Product Name:	TravelMate xxxx			
Manufacturer Name:	Acer			
UUID:	xxxxxxxxxxxxxxxx			
F1 Help	↑↓ Select Item	F5/F6 Change Values	F9 Setup defaults	
Esc Exit	←→ Select Menu	Enter Select ▸ Sub-Menu	F10 Save and Exit	

Invoking BIOS Setup

The setup function can only be invoked by pressing **F2** when Press <F2> to enter Setup message is prompted on the bottom of screen during POST.

The setup uses a menu driven interface to allow the user to configure their system. The features are divided into 5 parts as follows:

- Information** Display the system informations.
- Main** allows the user to specify standard IBM PC AT system parameters.
- Security** Provides security settings of the system.
- Boot** Allows the user to specify the boot options.
- Exit** Allows the user to save CMOS setting and exit Setup.

NOTE: You can change the value of a parameter if it is enclosed in square brackets. Navigation keys for a particular menu are shown on the bottom of the screen. Help for parameters are found in the Item Specific Help part of the screen. Read this carefully when making changes to parameter values.
Please note that system information is subject to different models.

Information

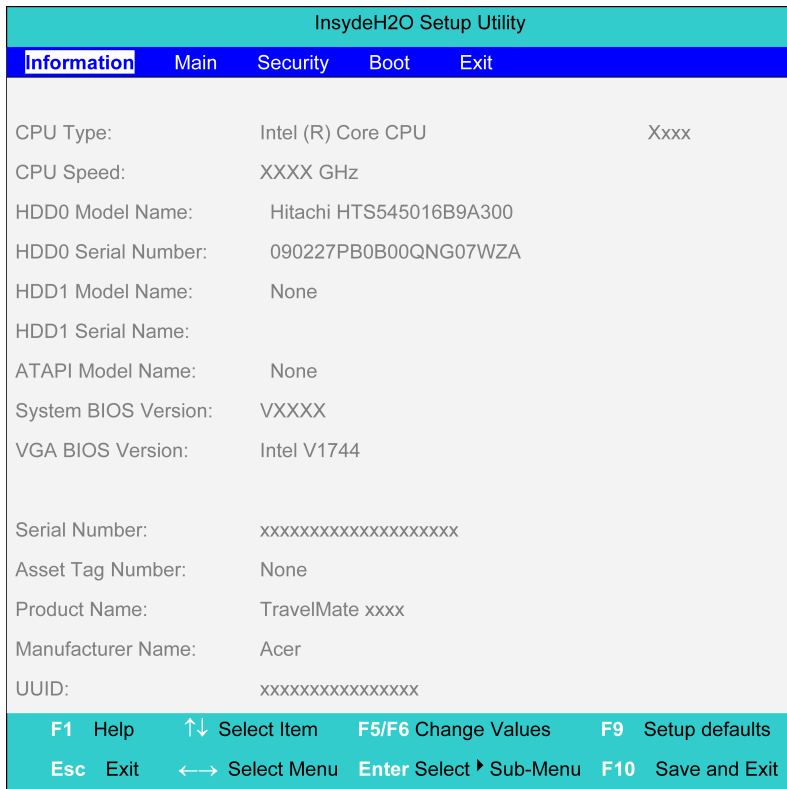

NOTE: The system information is subject to different models.

Parameter	Description
CPU Type	This field shows the CPU type of the system.
CPU Speed	This field shows the CPU speed of the system.
HDD0 Mode Name	This field shows the model name of HDD installed on primary master.
HDD0 Serial Number	This field displays the serial number of HDD installed on primary master.

Parameter	Description
HDD1 Mode Name	This field displays the model name of devices installed on secondary master. The hard disk drive or optical drive model name is automatically detected by the system.
HDD1 Serial Number	The field shows the serial number of devices installed on secondary master.
System BIOS version	Displays system BIOS version.
VGA BIOS Version	This field displays the VGA firmware version of the system.
Serial Number	This field displays the serial number of this unit.
Asset Tag Number	This field displays the asset tag number of the system.
Product Name	This field shows product name of the system.
Manufacturer Name	This field displays the manufacturer of this system.
UUID Number	This will be visible only when an internal LAN device is presenting. UUID=32bytes

Main

The Main screen displays a summary of your computer hardware information, and also includes basic setup parameters. It allows the user to specify standard IBM PC AT system parameters.

InsydeH2O Setup Utility		
Information	Main	Security Boot Exit
		Item specific Help
System Time:	[09:00:00]	
System Date:	[01/01/2007]	This is the help for the hour field. Valid range is from 0 to 23. REDUCE / INCREASE : F5/F6.
System Memory :	XXXX KB	
Total Memory	XXXX MB	
Video Memory :	[64MB]	
Quiet Boot:	[Enabled]	
Network Boot	[Enabled]	
F12 Boot Menu	[Disabled]	
D2D Recovery	[Enabled]	
SATA Mode	[AHCI Mode]	
F1 Help	↑↓ Select Item	F5/F6 Change Values F9 Setup defaults
Esc Exit	←→ Select Menu	Enter Select Sub-Menu F10 Save and Exit

NOTE: The screen above is for your reference only. Actual values may differ.

The table below describes the parameters in this screen. Settings in **boldface** are the default and suggested parameter settings.

Parameter	Description	Format/Option
System Time	Sets the system time. The hours are displayed with 24-hour format.	Format: HH:MM:SS (hour:minute:second) System Time
System Date	Sets the system date.	Format: MM/DD/YYYY (month/day/year) System Date
System Memory	This field reports the memory size of the system.	
Total Memory	This field reports the memory size of total memory in the system.	
Video Memor	Shows the Video memory size.	
Quiet Boot	Determines if Customer Logo will be displayed or not; shows Summary Screen is disabled or enabled. Enabled: Customer Logo is displayed, and Summary Screen is disabled. Disabled: Customer Logo is not displayed, and Summary Screen is enabled.	Option: Enabled or Disabled
Network Boot	Enables, disables the system boot from LAN (remote server).	Option: Enabled or Disabled
F12 Boot Menu	Enables, disables Boot Menu during POST.	Option: Disabled or Enabled
D2D Recovery	Enables, disables D2D Recovery function. The function allows the user to create a hidden partition on hard disc drive to store operation system and restore the system to factory defaults.	Option: Enabled or Disabled
SATA Mode	Choose which mode of HDD mode. Please be careful for changing this setting because it might cause system fail to boot.	Option: AHCI Mode or IDE Mode

NOTE: The sub-items under each device will not be shown if the device control is set to disable or auto. This is because the user is not allowed to control the settings in these cases.

Security

The Security screen contains parameters that help safeguard and protect your computer from unauthorized use.

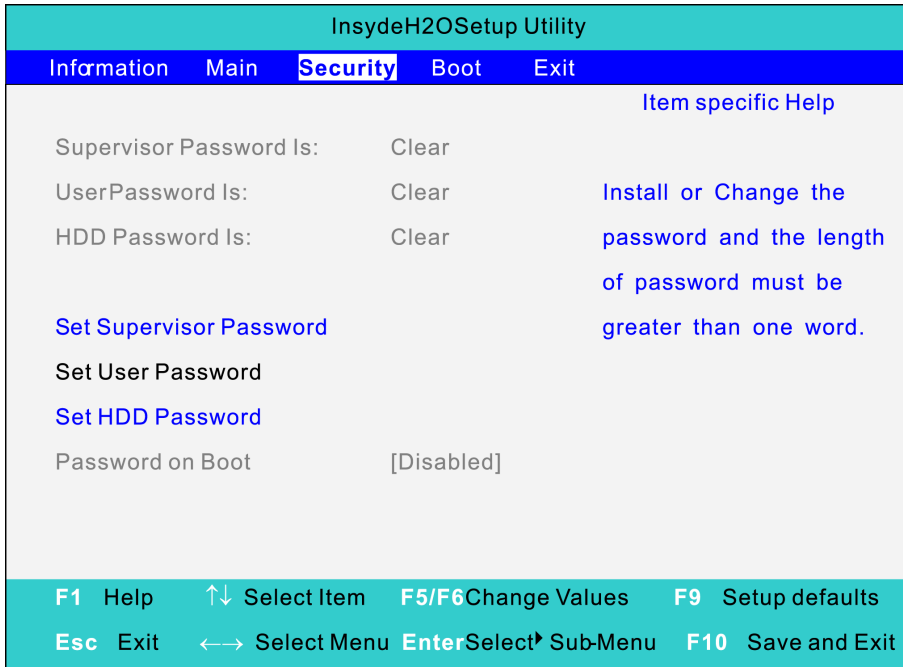

The table below describes the parameters in this screen. Settings in **boldface** are the default and suggested parameter settings.

Parameter	Description	Option
Supervisor Password is	Shows the setting of the Supervisor password.	Clear or Set
User Password is	Shows the setting of the user password.	Clear or Set
HDD Password is	Shows the setting of HDD password.	Clear or Set
Set Supervisor Password	Press Enter to set the supervisor password. When set, this password protects the BIOS Setup Utility from unauthorized access. The user can not enter the Setup menu and change the value of parameters.	
Set User Password	Press Enter to set the user password. When user password is set, this password protects the BIOS Setup Utility from unauthorized access. The user can enter Setup menu only and does not have right to change the value of parameters.	
Set Hdd Passwor	Press Enter to set the Hdd password. When Hdd password is set, this password protects the Hdd . Other user can't steal information.	
Password on Boot	Defines whether a password is required or not while the events defined in this group happened. The following sub-options are all requires the Supervisor password for changes and should be grayed out if the user password was used to enter setup.	Disabled or Enabled

NOTE: When you are prompted to enter a password, you have three tries before the system halts. Don't forget your password. If you forget your password, you may have to return your notebook computer to your dealer to reset it.

Setting a Password

Follow these steps as you set the user or the supervisor password:

1. Use the **w** and **y** keys to highlight the Set Supervisor Password parameter and press the **e** key. The Set Supervisor Password box appears:

Set Supervisor Password

Enter New Password []

Confirm New Password []

2. Type a password in the "Enter New Password" field. The password length can not exceeds 8 alphanumeric characters (**A-Z**, **a-z**, **0-9**, not case sensitive). Retype the password in the "Confirm New Password" field.

IMPORTANT: Be very careful when typing your password because the characters do not appear on the screen.

3. Press **e**.
After setting the password, the computer sets the User Password parameter to **"Set"**.

4. If desired, you can opt to enable the Password on boot parameter.
5. When you are done, press **u** to save the changes and exit the BIOS Setup Utility.

Removing a Password

Follow these steps:

1. Use the **w** and **y** keys to highlight the Set Supervisor Password parameter and press the **e** key. The Set Password box appears:

Set Supervisor Password		
Enter current password	[]
Enter New Password	[]
Confirm New Password	[]

2. Type the current password in the Enter Current Password field and press **e**.
3. Press **e** twice **without** typing anything in the Enter New Password and Confirm New Password fields. The computer then sets the Supervisor Password parameter to "**Clear**".
4. When you have changed the settings, press **u** to save the changes and exit the BIOS Setup Utility.

Changing a Password

1. Use the **w** and **y** keys to highlight the Set Supervisor Password parameter and press the **e** key. The Set Password box appears:

Set Supervisor Password		
Enter current password	[]
Enter New Password	[]
Confirm New Password	[]

2. Type the current password in the Enter Current Password field and press **e**.
3. Type a password in the Enter New Password field. Retype the password in the Confirm New Password field.
4. Press **e**. After setting the password, the computer sets the User Password parameter to "**Set**".
5. If desired, you can enable the Password on boot parameter.
6. When you are done, press **u** to save the changes and exit the BIOS Setup Utility.

If the verification is OK, the screen will display as following.

Setup Notice
Changes have been saved.
[continue]

The password setting is complete after the user presses **u**.

If the current password entered does not match the actual current password, the screen will show you the Setup Warning.

```
Setup Warning
Invalid password
Re-enter Password
[ continue]
```

If the new password and confirm new password strings do not match, the screen will display the following message.

```
Setup Warning
Password do not match
Re-enter Password
```

Boot

This menu allows the user to decide the order of boot devices to load the operating system. Bootable devices includes the distette drive in module bay, the onboard hard disk drive and the CD-ROM in module bay.

Insyde H2O Setup Utility				
Information	Main	Security	Boot	Exit
Boot priority order :			Item specific Help	
1: IDE0 : Hitachi HTS545016B3A345			Use < ↑ > or < ↓ > to select a device, then press < F6 > to move it up the List, or < F5 > to move it down the list. Press < Esc > to escape the menu	
2: IDE1 :				
3: IDE2 :				
4: Network Boot :				
5. USB HDD :				
6. USB FDD :				
F1 Help	↑↓ Select Item	F5/F6 Change Values	F9 Setup defaults	
Esc Exit	←→ Select Menu	Enter Select Sub-Menu	F10 Save and Exit	

Exit

The Exit screen contains parameters that help safeguard and protect your computer from unauthorized use.

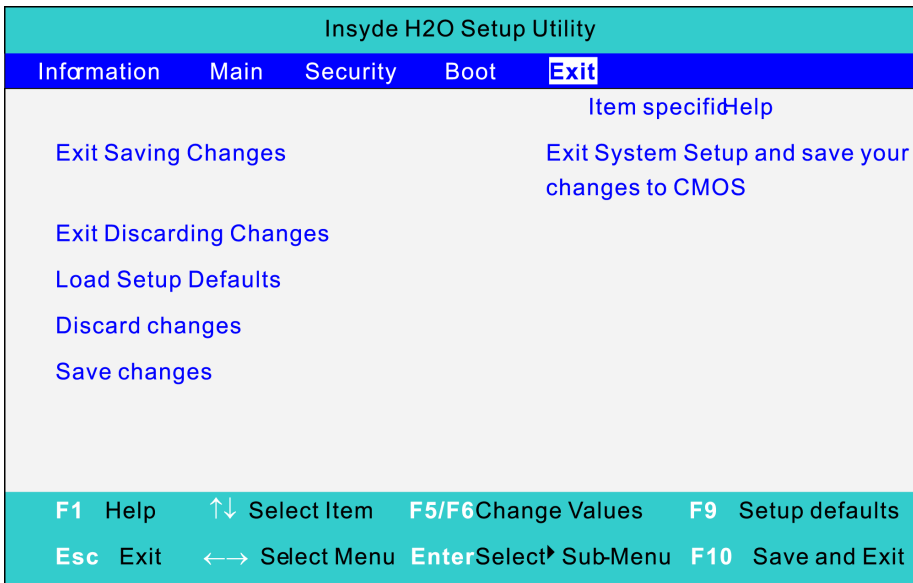

The table below describes the parameters in this screen.

Parameter	Description
Exit Saving Changes	Exit System Setup and save your changes to CMOS.
Exit Discarding Changes	Exit utility without saving setup data to CMOS.
Load Setup Default	Load default values for all SETUP item.
Discard Changes	Load previous values from CMOS for all SETUP items.
Save Changes	Save Setup Data to CMOS.

BIOS Flash Utility

The BIOS flash memory update is required for the following conditions:

- New versions of system programs
- New features or options
- Restore a BIOS when it becomes corrupted.

Use the Phlash utility to update the system BIOS flash ROM.

NOTE: If you do not have a crisis recovery diskette at hand, then you should create a **Crisis Recovery Diskette** before you use the Phlash utility.

NOTE: Do not install memory-related drivers (XMS, EMS, DPMS) when you use the Phlash.

NOTE: Please use the AC adaptor power supply when you run the Phlash utility. If the battery pack does not contain enough power to finish BIOS flash, you may not boot the system because the BIOS is not completely loaded.

Follow the steps below to run the Phlash.

1. Prepare a bootable diskette.
2. Copy the flash utilities to the bootable diskette.
3. Then boot the system from the bootable diskette. The flash utility has auto-execution function.

Machine Disassembly and Replacement

This chapter contains step-by-step procedures on how to disassemble the notebook computer TravelMate 8471/8431 for maintenance and troubleshooting.

To disassemble the computer, you need the following tools:

- Wrist grounding strap and conductive mat for preventing electrostatic discharge
- Small Philips screw driver
- Philips screwdriver
- Plastic flat head screw driver
- Tweezers

NOTE: The screws for the different components vary in size. During the disassembly process, group the screws with the corresponding components to avoid mismatch when putting back the components. When you remove the stripe cover, please be careful not to scrape the cover.

General Information

Before You Begin

Before proceeding with the disassembly procedure, make sure that you do the following:

1. Turn off the power to the system and all peripherals.
2. Unplug the AC adapter and all power and signal cables from the system.
3. Remove the battery pack.

Disassembly Procedure Flowchart

The flowchart on the succeeding page gives you a graphic representation on the entire disassembly sequence and instructs you on the components that need to be removed during servicing. For example, if you want to remove the system board, you must first remove the keyboard, then disassemble the inside assembly frame in that order.

Main unit disassembly flow chart

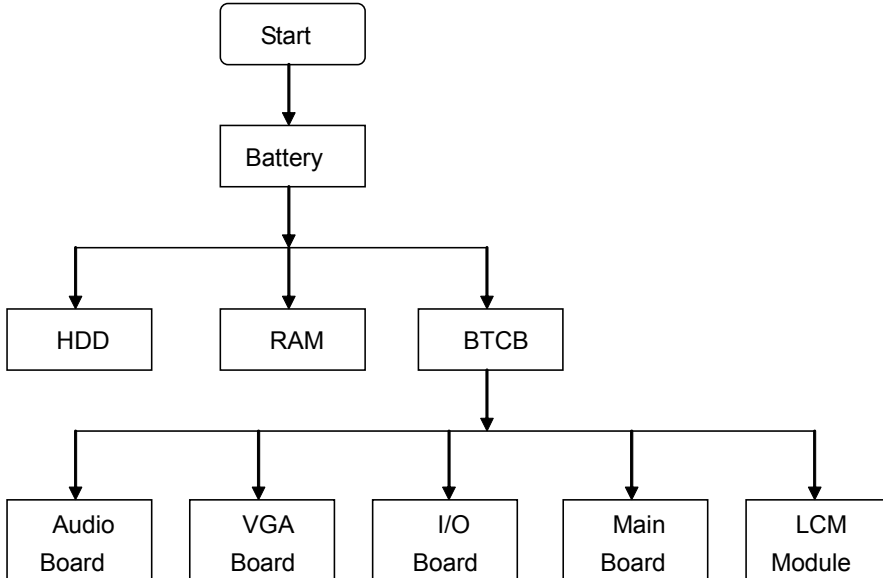

LCM module disassembly flow chart

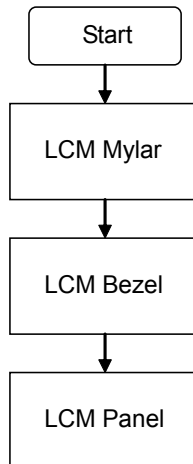

Removing the Battery Pack

1. Release the battery lock.
2. Slide the battery latch then remove the battery.



NOTE: Battery has been highlighted with the yellow circle as above image shows. Please detach the battery and follow local regulations for disposal.

Removing the HDD and RAM

1. Remove two screws on the HDD cover and remove HDD.



	Type	Number
	M2*5(4.5D*0.8T)	2

2. Remove the screw on RAM cover and remove RAM.

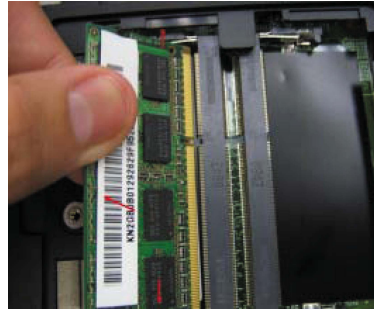

	Type	Number
	M2*5(4.5D*0.8T)	1



NOTE: RTC battery has been highlighted with the yellow circle as above image shows. Please detach the RTC battery and follow local regulations for disposal.

3. Remove the wireless card.



4. Remove ODD.



- Use the sleeve to remove the rubber and remove all of the screw on the back of the BAP41.



	<p style="text-align: center;">Type</p> <p>M2*5(4.5D*0.8T)</p>	<p style="text-align: center;">Number</p> <p style="text-align: center;">15</p>
	<p style="text-align: center;">Type</p> <p>M2*5(4.5D*0.5T)</p>	<p style="text-align: center;">Number</p> <p style="text-align: center;">5</p>

Remove Keyboard

- Disconnect five latches on the keyboard.

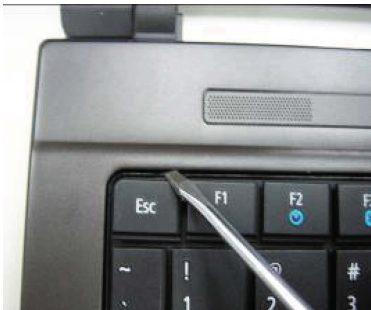



- Remove the FFC behind the keyboard.

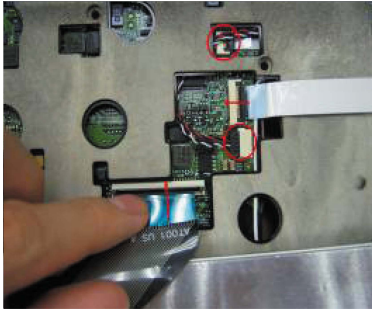

Remove FFC of main board and sub board

1. Remove screw and FFC on the topper case and remove the topper case.



	<p style="text-align: center;">Type</p> <p>M2*5(4.5D*0.8T)</p>	<p style="text-align: center;">Number</p> <p style="text-align: center;">8</p>
--	---	---

2. Remove Power Board.

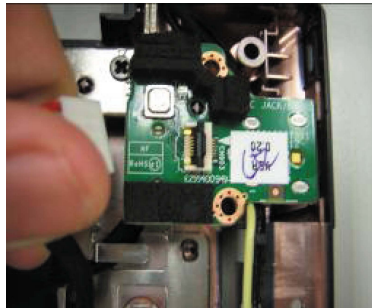
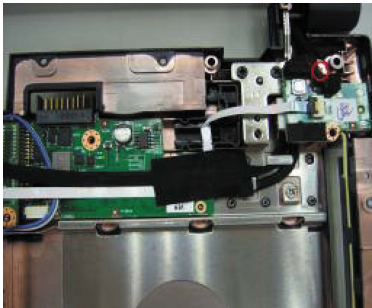

3. Remove the FFC and screw on the Wireless board.

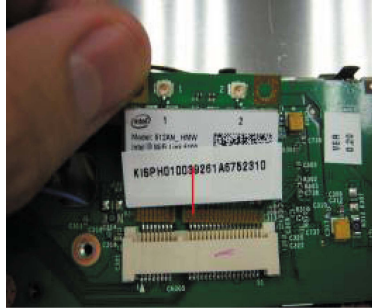

	Type	Number
	M2*5(4.5D*0.8T)	1

4. Remove the FFC on the panel and remove Card reader board.

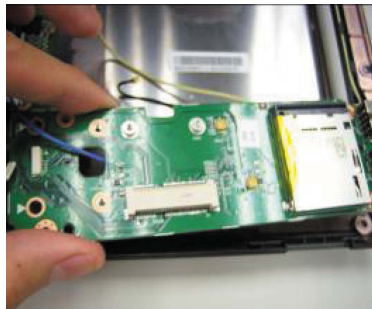
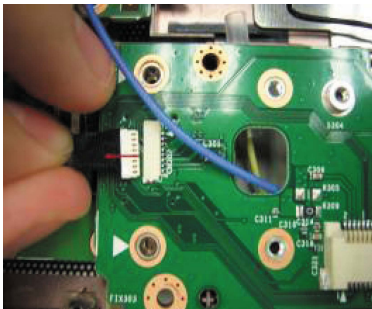

5. Remove connector on the audio board and remove two screws on it.

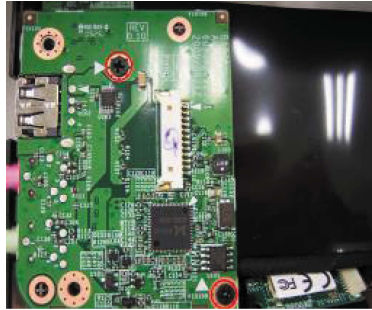
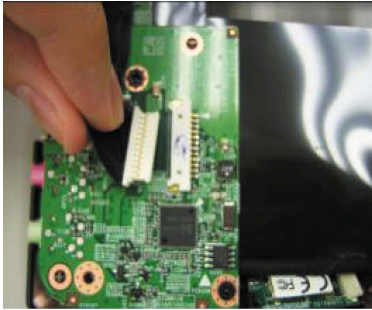

6. Remove the cable on the back of audio board.

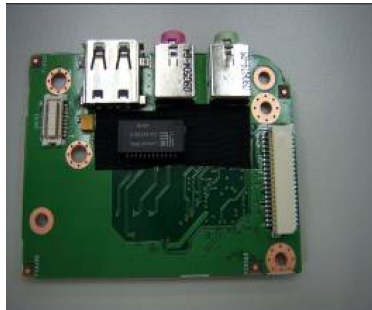
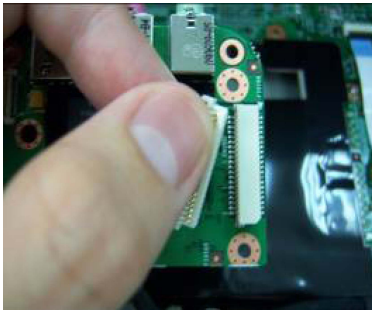

	<p style="text-align: center;">Type</p> <p>M2*5(4.5D*0.8T)</p>	<p style="text-align: center;">Number</p> <p style="text-align: center;">1</p>
--	---	---

7. Remove the connector of Bluetooth.

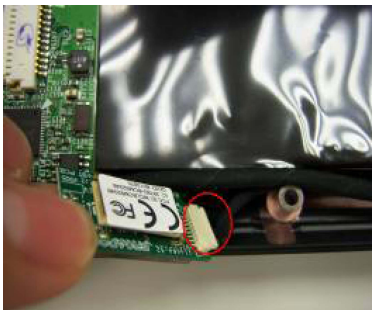

8. Remove the cable of LCD and Connector of Fan.

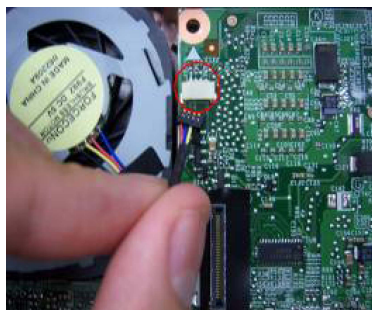
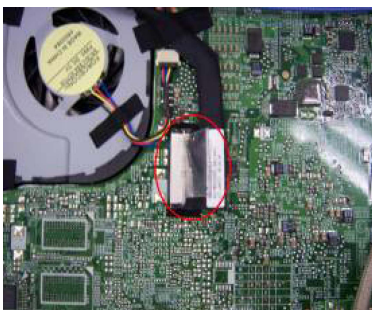

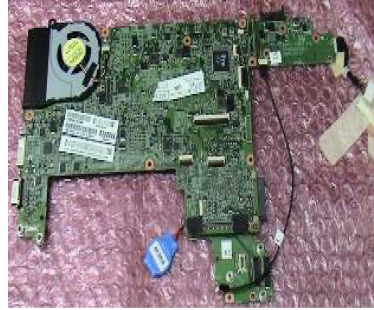

9. Remove the mainboard.



Remove Panel

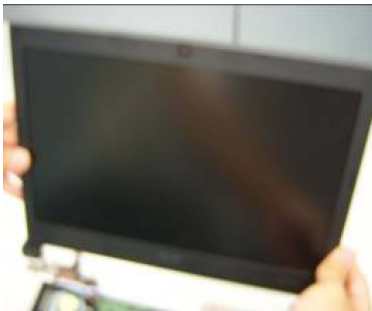
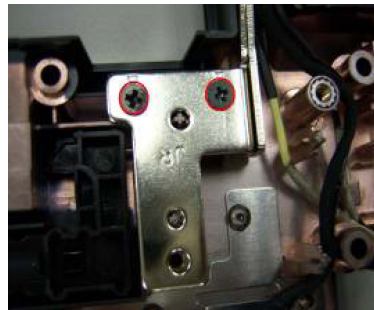
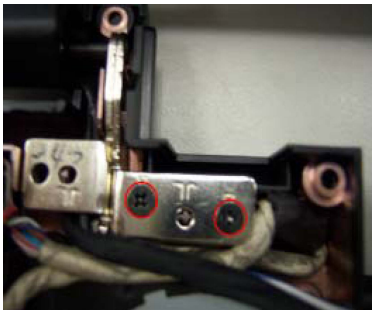

1. Remove four screws on the bottom of panel and remove the panel.



	Type	Number
	M2*5(4.5D*0.8T)	1

2. Remove four sponges on the LCD and remove four screws under them.



	Type	Number
	M2*4(4.5D*0.5T)	2
	Type	Number
	M2*3(4.5D*0.8T)	2

3. Remove the bezel on the panel and remove four screws on it.



-
4. Remove LCM cable on the back of panel.



Disassembling the External Module

Disassembling the HDD Module

1. Remove HDD bezel and get HDD out of cover.

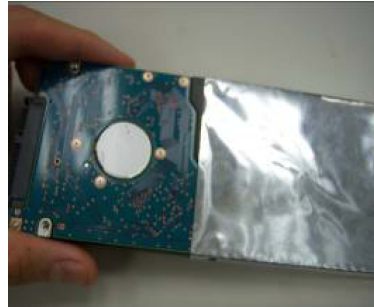
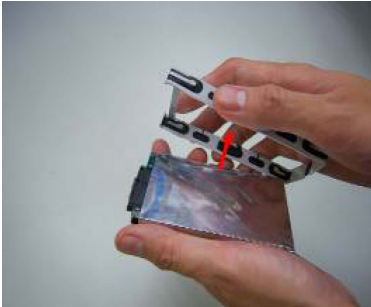

Troubleshooting

Use the following procedure as a guide for computer problems.

NOTE: The diagnostic tests are intended to test only Acer products. Non-Acer products, prototype cards, or modified options can give false errors and invalid system responses.

1. Obtain the failing symptoms in as much detail as possible.
2. Verify the symptoms by attempting to re-create the failure by running the diagnostic test or by repeating the same operation.
3. Use the following table with the verified symptom to determine which page to go to.

Symptoms (Verified)	Go To
Power failure. (The power indicator does not go on or stay on.)	"Power System Check" on page 53.
POST does not complete. No beep or error codes are indicated.	"Power-On Self-Test (POST) Error Message" on page 55. "Undetermined Problems" on page 68.
POST detects an error and displayed messages on screen.	"Error Message List" on page 56.
Other symptoms (i.e. LCD display problems or others).	"Power-On Self-Test (POST) Error Message" on page 55.
Symptoms cannot be re-created (intermittent problems).	Use the customer-reported symptoms and go to "Power-On Self-Test (POST) Error Message" on page 55. "Intermittent Problems" on page 67. "Undetermined Problems" on page 68.

System Check Procedures

External Diskette Drive Check

Do the following to isolate the problem to a controller, driver, or diskette. A write-enabled, diagnostic diskette is required.

NOTE: Make sure that the diskette does not have more than one label attached to it. Multiple labels can cause damage to the drive or cause the drive to fail.

Do the following to select the test device.

1. Boot from the diagnostics diskette and start the diagnostics program.
2. See if FDD Test is passed as the program runs to FDD Test.
3. Follow the instructions in the message window.

If an error occurs with the internal diskette drive, reconnect the diskette connector on the system board.

If the error still remains:

1. Reconnect the external diskette drive/DVD-ROM module.
2. Replace the external diskette drive/CD-ROM module.
3. Replace the main board.

External CD-ROM Drive Check

Do the following to isolate the problem to a controller, drive, or CD-ROM. Make sure that the CD-ROM does not have any label attached to it. The label can cause damage to the drive or can cause the drive to fail.

Do the following to select the test device:

1. Boot from the diagnostics diskette and start the diagnostics program.
2. See if CD-ROM Test is passed when the program runs to CD-ROM Test.
3. Follow the instructions in the message window.

If an error occurs, reconnect the connector on the System board. If the error still remains:

1. Reconnect the external diskette drive/CD-ROM module.
2. Replace the external diskette drive/CD-ROM module.
3. Replace the main board.

Keyboard or Auxiliary Input Device Check

Remove the external keyboard if the internal keyboard is to be tested.

If the internal keyboard does not work or an unexpected character appears, make sure that the flexible cable extending from the keyboard is correctly seated in the connector on the system board.

If the keyboard cable connection is correct, run the Keyboard Test.

If the tests detect a keyboard problem, do the following one at a time to correct the problem. Do not replace a non-defective FRU:

1. Reconnect the keyboard cables.
2. Replace the keyboard.
3. Replace the main board.

The following auxiliary input devices are supported by this computer:

- Numeric keypad
- External keyboard

If any of these devices do not work, reconnect the cable connector and repeat the failing operation.

Memory check

Memory errors might stop system operations, show error messages on the screen, or hang the system.

1. Boot from the diagnostics diskette and start the doagmpstotics program (please refer to main board.)
2. Go to the diagnostic memory in the test items.
3. Press F2 in the test items.
4. Follow the instructions in the message window.

NOTE: Make sure that the DIMM is fully installed into the connector. A loose connection can cause an error.

Power System Check

To verify the symptom of the problem, power on the computer using each of the following power sources:

1. Remove the battery pack.
2. Connect the power adapter and check that power is supplied.
3. Disconnect the power adapter and install the charged battery pack; then check that power is supplied by the battery pack.

If you suspect a power problem, see the appropriate power supply check in the following list:

- “Check the Power Adapter” on page 53
- “Check the Battery Pack” on page 53

Check the Power Adapter

Unplug the power adapter cable from the computer and measure the output voltage at the plug of the power adapter cable. See the following figure:

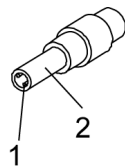

Pin 1: +19 to +20.5V
Pin 2: 0V, Ground

1. If the voltage is not correct, replace the power adapter.
2. If the voltage is within the range, do the following:
 - Replace the System board.
 - If the problem is not corrected, see “Undetermined Problems” on page 68.
 - If the voltage is not correct, go to the next step.

NOTE: An audible noise from the power adapter does not always indicate a defect.

3. If the power-on indicator does not light up, check the power cord of the power adapter for correct continuity and installation.
4. If the operational charge does not work, see “Check the Battery Pack” on page 53.

Check the Battery Pack

To check the battery pack, do the following:

From Software:

1. Check out the Power Management in control Panel.
2. In Power Meter, confirm that if the parameters shown in the screen for Current Power Source and Total Battery Power Remaining are correct.
3. Repeat the steps 1 and 2, for both battery and adapter.
4. This helps you identify first the problem is on recharging or discharging.

From Hardware:

1. Power off the computer.
2. Remove the battery pack and measure the voltage between battery terminals 1(+) and 6(ground). See the following figure.

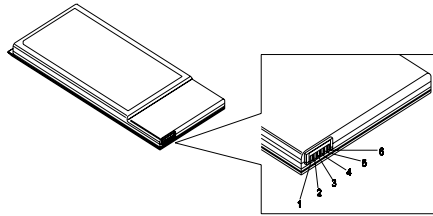

3. If the voltage is still less than 7.5 Vdc after recharging, replace the battery.

To check the battery charge operation, use a discharged battery pack or a battery pack that has less than 50% of the total power remaining when installed in the computer.

If the battery status indicator does not light up, remove the battery pack and let it return to room temperature. Re-install the battery pack.

If the charge indicator still does not light up, replace the battery pack. If the charge indicator still does not light up, replace the DC/DC charger board.

Touchpad Check

If the touchpad doesn't work, do the following actions one at a time to correct the problem. Do not replace a non-defective FRU:

1. Reconnect the touchpad cables.
2. Replace the touchpad.
3. Replace the system board.

After you use the touchpad, the pointer drifts on the screen for a short time. This self-acting pointer movement can occur when a slight, steady pressure is applied to the touchpad pointer. This symptom is not a hardware problem. No service actions are necessary if the pointer movement stops in a short period of time.

Power-On Self-Test (POST) Error Message

The POST error message index lists the error message and their possible causes. The most likely cause is listed first.

NOTE: Perform the FRU replacement or actions in the sequence shown in FRU/Action column, if the FRU replacement does not solve the problem, put the original part back in the computer. Do not replace a non-defective FRU.

This index can also help you determine the next possible FRU to be replaced when servicing a computer.

If the symptom is not listed, see “Undetermined Problems” on page 68.

The following lists the error messages that the BIOS displays on the screen and the error symptoms classified by function.

NOTE: Most of the error messages occur during POST. Some of them display information about a hardware device, e.g., the amount of memory installed. Others may indicate a problem with a device, such as the way it has been configured.

NOTE: If the system fails after you make changes in the BIOS Setup Utility menus, reset the computer, enter Setup and install Setup defaults or correct the error.

Index of Error Messages

Error Code List

Error Codes	Error Messages
006	Equipment Configuration Error Causes: 1. CPU BIOS Update Code Mismatch. 2. IDE Primary Channel Master Drive Error. (The causes will be shown before "Equipment Configuration Error")
010	Memory Error at xxxx:xxxx:xxxxh (R:xxxxh, W:xxxxh) .
070	Real Time Clock Error.
071	CMOS Battery Bad.
072	CMOS Checksum Error.
110	System disabled. Incorrect password is specified.
<No error code>	Battery critical LOW. In this situation BIOS will issue 4 short beeps then shut down system, no message will show.
<No error code>	Thermal critical High. In this situation BIOS will shut down system, not show message.

Error Message List

Error Messages	FRU/Action in Sequence
Failure Fixed Disk	Reconnect hard disk drive connector. "Load Default Settings" in BIOS Setup Utility. Hard disk drive System board
Stuck Key	see "Keyboard or Auxiliary Input Device Check" on page 52.
Keyboard error	see "Keyboard or Auxiliary Input Device Check" on page 52.
Keyboard Controller Failed	see "Keyboard or Auxiliary Input Device Check" on page 52.
Keyboard locked - Unlock key switch	Unlock external keyboard.
Monitor type does not match CMOS - Run Setup	Run "Load Default Settings" in BIOS Setup Utility.
Shadow RAM Failed at offset: nnnn	BIOS ROM System board
System RAM Failed at offset: nnnn	DIMM System board
Extended RAM Failed at offset: nnnn	DIMM System board

Error Messages	FRU/Action in Sequence
System battery is dead - Replace and run Setup	Replace RTC battery and Run BIOS Setup Utility to reconfigure system time, then reboot system.
System CMOS checksum bad - Default configuration used	RTC battery Run BIOS Setup Utility to reconfigure system time, then reboot system.
System timer error	RTC battery Run BIOS Setup Utility to reconfigure system time, then reboot system. System board
Real time clock error	RTC battery Run BIOS Setup Utility to reconfigure system time, then reboot system. System board
Previous boot incomplete - Default configuration used	Run "Load Default Settings" in BIOS Setup Utility. RTC battery System board
Memory size found by POST differed from CMOS	Run "Load Default Settings" in BIOS Setup Utility. DIMM System board
Diskette drive A error	Check the drive is defined with the proper diskette type in BIOS Setup Utility. See "External Diskette Drive Check" on page 52.
Incorrect Drive A type - run SETUP	Check the drive is defined with the proper diskette type in BIOS Setup Utility.
System cache error - Cache disabled	System board
CPU ID:	System board
DMA Test Failed	DIMM System board
Software NMI Failed	DIMM System board
Fail-Safe Timer NMI Failed	DIMM System board
Device Address Conflict	Run "Load Default Settings" in BIOS Setup Utility. RTC battery System board
Allocation Error for device	Run "Load Default Settings" in BIOS Setup Utility. RTC battery System board
Failing Bits: nnnn	DIMM BIOS ROM System board
Fixed Disk n	None

Error Messages	FRU/Action in Sequence
Invalid System Configuration Data	BIOS ROM System board
I/O device IRQ conflict	Run "Load Default Settings" in BIOS Setup Utility. RTC battery System board
Operating system not found	Enter Setup and see if fixed disk and drive A are properly identified. Diskette drive Hard disk drive System board

Error Message List

No beep Error Messages	FRU/Action in Sequence
No beep, power-on indicator turns off and LCD is blank.	Power source (battery pack and power adapter). See "Power System Check" on page 53. Ensure every connector is connected tightly and correctly. Reconnect the DIMM. LED board System board
No beep, power-on indicator turns on and LCD is blank.	Power source (battery pack and power adapter). See "Power System Check" on page 53. Reconnect the LCD connector. Hard disk drive LCD inverter ID LCD cable LCD Inverter LCD System board
No beep, power-on indicator turns on and LCD is blank. But you can see POST on an external CRT.	Reconnect the LCD connectors. LCD inverter ID LCD cable LCD inverter LCD System board
No beep, power-on indicator turns on and a blinking cursor shown on LCD during POST.	Ensure every connector is connected tightly and correctly. System board
No beep during POST but system runs correctly.	Speaker System board

InsydeH2O BIOS Beep Codes

Code	Beeps	POST Routine Description
02h		Verify Real Mode
03h		Disable Non-Maskable Interrupt (NMI)
04h		Get CPU type
06h		Initialize system hardware
08h		Initialize chipset with initial POST values
09h		Set IN POST flag
0Ah		Initialize CPU registers
0Bh		Enable CPU cache
0Ch		Initialize caches to initial POST values
0Eh		Initialize I/O component
0Fh		Initialize the local bus IDE
10h		Initialize Power Management
11h		Load alternate registers with initial POST values
12h		Restore CPU control word during warm boot
13h		Initialize PCI Bus Mastering devices
14h		Initialize keyboard controller
16h	1-2-2-3	BIOS ROM checksum
17h		Initialize cache before memory autosize
18h		8254 timer initialization
1Ah		8237 DMA controller initialization
1Ch		Reset Programmable Interrupt Controller
20h	1-3-1-1	Test DRAM refresh
22h	1-3-1-3	Test 8742 Keyboard Controller
24h		Set ES segment register to 4 GB
26h		Enable A20 line
28h		Autosize DRAM
29h		Initialize POST Memory Manager
2Ah		Clear 215 KB base RAM
2Ch	1-3-4-1	RAM failure on address line xxxx
2Eh	1-3-4-3	RAM failure on data bits xxxx of low byte of memory bus
2Fh		Enable cache before system BIOS shadow
30h	1-4-1-1	RAM failure on data bits xxxx of high byte of memory bus
32h		Test CPU bus-clock frequency
33h		Initialize InsydeH2O Dispatch Manager
36h		Warm start shut down
38h		Shadow system BIOS ROM
3Ah		Autosize cache
3Ch		Advanced configuration of chipset registers
3Dh		Load alternate registers with CMOS values
42h		Initialize interrupt vectors

Code	Beeps	POST Routine Description
45h		POST device initialization
46h	2-1-2-3	Check ROM copyright notice
48h		Check video configuration against CMOS
49h		Initialize PCI bus and devices
4Ah		Initialize all video adapters in system
4Bh		QuietBoot start (optional)
4Ch		Shadow video BIOS ROM
4Eh		Display BIOS copyright notice
50h		Display CPU type and speed
51h		Initialize EISA board
52h		Test keyboard
54h		Set key click if enabled
58h	2-2-3-1	Test for unexpected interrupts
59h		Initialize POST display service
5Ah		Display prompt "Press F2 to enter SETUP"
5Bh		Disable CPU cache
5Ch		Test RAM between 512 and 640 KB
60h		Test extended memory
62h		Test extended memory address lines
64h		Jump to User Patch1
66h		Configure advanced cache registers
67h		Initialize Multi Processor APIC
68h		Enable external and CPU caches
69h		Setup System Management Mode (SMM) area
6Ah		Display external L2 cache size
6Bh		Load custom defaults (optional)
6Ch		Display shadow-area message
6Eh		Display possible high address for UMB recovery
70h		Display error messages
72h		Check for configuration errors
76h		Check for keyboard errors
7Ch		Set up hardware interrupt vectors
7Eh		Initialize coprocessor if present
80h		Disable onboard Super I/O ports and IRQs
81h		Late POST device initialization
82h		Detect and install external RS232 ports
83h		Configure non-MCD IDE controllers
84h		Detect and install external parallel ports
85h		Initialize PC-compatible PnP ISA devices
86h		Re-initialize onboard I/O ports
87h		Configure Motherboard Configurable Devices (optional)
88h		Initialize BIOS Area
89h		Enable Non-Maskable Interrupts (NMIs)

Code	Beeps	POST Routine Description
8Ah		Initialize Extended BIOS Data Area
8Bh		Test and initialize PS/2 mouse
8Ch		Initialize floppy controller
8Fh		Determine number of ATA drives (optional)
90h		Initialize hard-disk controllers
91h		Initialize local-bus hard-disk controllers
92h		Jump to UserPatch2
93h		Build MPTABLE for multi-processor boards
95h		Install CD ROM for boot
96h		Clear huge ES segment register
97h		Fixup Multi Processor table
98h	1-2	Search for option ROMs. One long, two short beeps on checksum failure.
99h		Check for SMART drive (optional)
9Ah		Shadow option ROMs
9Ch		Set up Power Management
9Dh		Initialize security engine (optional)
9Eh		Enable hardware interrupts
9Fh		Determine number of ATA and SCSI drives
A0h		Set time of day
A2h		Check key lock
A4h		Initialize Typematic rate
A8h		Erase F2 prompt
AAh		Scan for F2 key stroke
ACh		Enter SETUP
AEh		Clear Boot flag
B0h		Check for errors
B2h		POST done- prepare to boot operating system
B4h	1	One short beep before boot
B5h		Terminate QuietBoot (optional)
B6h		Check password (optional)
B9h		Prepare Boot
BAh		Initialize DMI parameters
BBh		Initialize PnP Option ROMs
BCh		Clear parity checkers
BDh		Display MultiBoot menu
BEh		Clear screen (optional)
BFh		Check virus and backup reminders
C0h		Try to boot with INT 19
C1h		Initialize POST Error Manager (PEM)
C2h		Initialize error logging
C3h		Initialize error display function
C4h		Initialize system error handler

Code	Beeps	POST Routine Description
C5h		PnPnd dual CMOS (optional)
C6h		Initialize notebook docking (optional)
C7h		Initialize notebook docking late
C8h		Force check (optional)
C9h		Extended checksum (optional)
D2h		Unknown interrupt
E0h		Initialize the chipset
E1h		Initialize the bridge
E2h		Initialize the CPU
E3h		Initialize the system timer
E4h		Initialize system I/O
E5h		Check force recovery boot
E6h		Checksum BIOS ROM
E7h		Go to BIOS
E8h		Set Huge Segment
E9h		Initialize Multi Processor
EAh		Initialize OEM special code
EBh		Initialize PIC and DMA
ECh		Initialize Memory type
EDh		Initialize Memory size
EEh		Shadow Boot Block
EFh		System memory test
F0h		Initialize interrupt vectors
F1h		Initialize Run Time Clock
F2h		Initialize video
F3h		Initialize System Management Mode
F4h	1	Output one beep before boot
F5h		Boot to Mini DOS
F6h		Clear Huge Segment
F7h		Boot to Full DOS

Index of Symptom-to-FRU Error Message

LCD-Related Symptoms

Symptom / Error	Action in Sequence
LCD backlight doesn't work LCD is too dark LCD brightness cannot be adjusted LCD contrast cannot be adjusted	Enter BIOS Utility to execute "Load Setup Default Settings", then reboot system. Reconnect the LCD connectors. Keyboard (if contrast and brightness function key doesn't work). LCD inverter ID LCD cable LCD inverter LCD System board
Unreadable LCD screen Missing pels in characters Abnormal screen Wrong color displayed	Reconnect the LCD connector LCD inverter ID LCD cable LCD inverter LCD System board
LCD has extra horizontal or vertical lines displayed.	LCD inverter ID LCD inverter LCD cable LCD System board

Indicator-Related Symptoms

Symptom / Error	Action in Sequence
Indicator incorrectly remains off or on, but system runs correctly.	Reconnect the inverter board Inverter board System board

Power-Related Symptoms

Symptom / Error	Action in Sequence
Power shuts down during operation.	Power source (battery pack and power adapter). See "Power System Check" on page 53. Battery pack Power adapter Hard drive & battery connection board System board
The system doesn't power-on.	Power source (battery pack and power adapter). See "Power System Check" on page 53. Battery pack Power adapter Hard drive & battery connection board System board

Symptom / Error	Action in Sequence
The system doesn't power-off.	Power source (battery pack and power adapter). See "Power System Check" on page 53. Hold and press the power switch for more than 4 seconds. System board
Battery can't be charged.	See "Check the Battery Pack" on page 53. Battery pack System board

PCMCIA-Related Symptoms

Symptom / Error	Action in Sequence
System cannot detect the PC Card (PCMCIA).	PCMCIA slot assembly System board
PCMCIA slot pin is damaged.	PCMCIA slot assembly

Memory-Related Symptoms

Symptom / Error	Action in Sequence
Memory count (size) appears different from actual size.	Enter BIOS Setup Utility to execute "Load Default Settings", then reboot system. DIMM System board

Speaker-Related Symptoms

Symptom / Error	Action in Sequence
In Windows, multimedia programs, no sound comes from the computer.	Audio driver Speaker System board
Internal speakers make noise or emit no sound.	Speaker System board

Power Management-Related Symptoms

Symptom / Error	Action in Sequence
The system will not enter hibernation.	Keyboard (if control is from the keyboard) Hard disk drive System board
The system doesn't enter hibernation mode and four short beeps every minute.	Press Fn+0 and see if the computer enters hibernation mode. Touchpad Keyboard Hard disk connection board Hard disk drive System board
The system doesn't enter standby mode after closing the LCD.	LCD cover switch System board

Symptom / Error	Action in Sequence
The system doesn't resume from hibernation mode.	Hard disk connection board Hard disk drive System board
The system doesn't resume from standby mode after opening the LCD.	LCD cover switch System board
Battery fuel gauge in Windows doesn't go higher than 90%.	Remove battery pack and let it cool for 2 hours. Refresh battery (continue use battery until power off, then charge battery). Battery pack System board
System hangs intermittently.	Reconnect hard disk/CD-ROM drives. Hard disk connection board System board

Peripheral-Related Symptoms

Symptom / Error	Action in Sequence
System configuration does not match the installed devices.	Enter BIOS Setup Utility to execute “Load Default Settings”, then reboot system. Reconnect hard disk/CD-ROM/diskette drives.
External display does not work correctly.	Press Fn+F5, LCD/CRT/Both display switching. System board
USB does not work correctly.	System board
Print problems.	Ensure the “Parallel Port” in the “Onboard Devices Configuration” of BIOS Setup Utility is set to Enabled. Onboard Devices Configuration Run printer self-test. Printer driver Printer cable Printer System Board
Serial or parallel port device problems.	Ensure the “Serial Port” in the Devices Configuration” of BIOS Setup Utility is set to Enabled. Device driver Device cable Device System board

Keyboard/Touchpad-Related Symptoms

Symptom / Error	Action in Sequence
Keyboard (one or more keys) does not work.	Reconnect the keyboard cable. Keyboard System board
Touchpad does not work.	Reconnect touchpad cable. Touchpad board System board

Modem-Related Symptoms

Symptom / Error	Action in Sequence
Internal modem does not work correctly.	Modem phone port modem combo board System board

NOTE: If you cannot find a symptom or an error in this list and the problem remains, see “Undetermined Problems” on page 68.

Intermittent Problems

Intermittent system hang problems can be caused by a variety of reasons that have nothing to do with a hardware defect, such as: cosmic radiation, electrostatic discharge, or software errors. FRU replacement should be considered only when a recurring problem exists.

When analyzing an intermittent problem, do the following:

1. Run the advanced diagnostic test for the system board in loop mode at least 10 times.
2. If no error is detected, do not replace any FRU.
3. If any error is detected, replace the FRU. Rerun the test to verify that there are no more errors.

Undetermined Problems

The diagnostic problems does not identify which adapter or device failed, which installed devices are incorrect, whether a short circuit is suspected, or whether the system is inoperative.

Follow these procedures to isolate the failing FRU (do not isolate non-defective FRU).

NOTE: Verify that all attached devices are supported by the computer.

NOTE: Verify that the power supply being used at the time of the failure is operating correctly. (See "Power System Check" on page 53).

1. Power-off the computer.
2. Visually check them for damage. If any problems are found, replace the FRU.
3. Remove or disconnect all of the following devices:
 - Non-Acer devices
 - Printer, mouse, and other external devices
 - Battery pack
 - Hard disk drive
 - DIMM
 - CD-ROM/Diskette drive Module
 - PC Cards
4. Power-on the computer.
5. Determine if the problem has changed.
6. If the problem does not recur, reconnect the removed devices one at a time until you find the failing FRU.
7. If the problem remains, replace the following FRU one at a time. Do not replace a non-defective FRU:
 - System board
 - LCD assembly

Jumper and Connector Locations

Top View

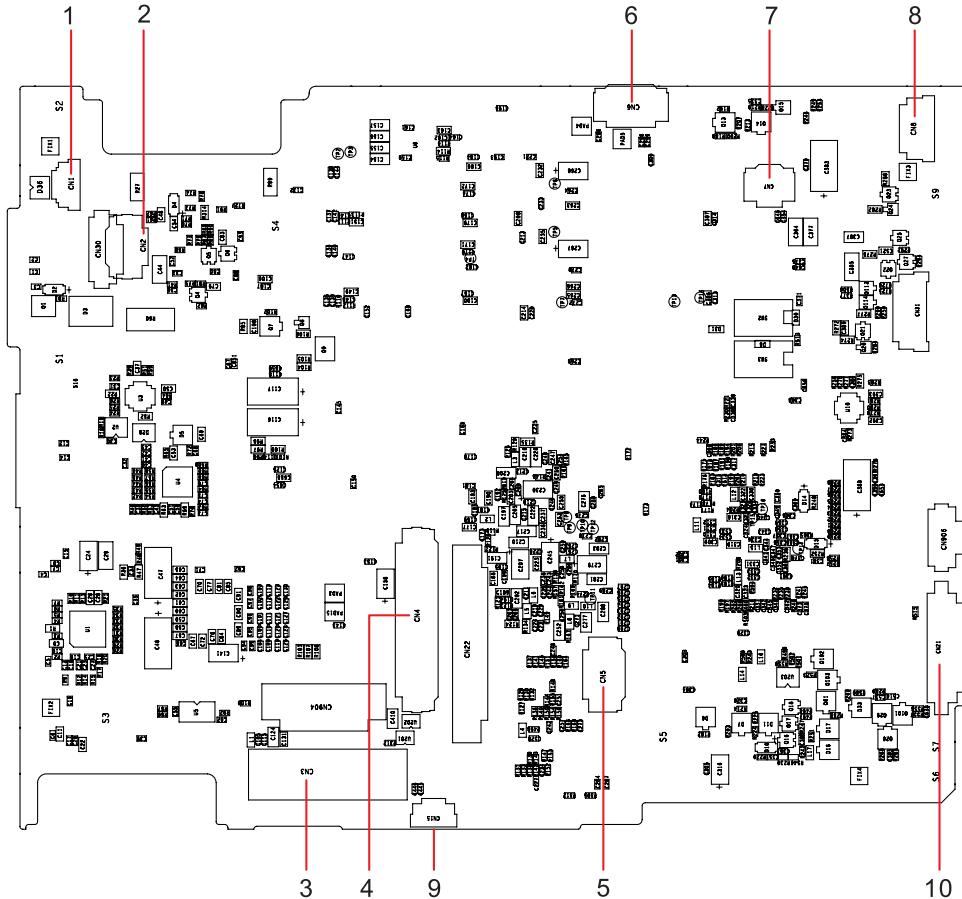

TravelMate 8471/8431 M/B layout and connector location TOP view		
No.	Name	Description
1	CN1	CCD cable CNTR
2	CN2	MMB cable CNTR
3	CN3	LVDS cable CNTR
4	CN4	Keyboard CNTR
5	CN5	Touch Pad FFC CNTR
6	CN6	SSD cable CNTR
7	CN7	Card reader CNTR
8	CN8	BT cable CNTR
9	CN15	Fan cable CNTR
10	CN21	Audio board CNTR

Bottom View

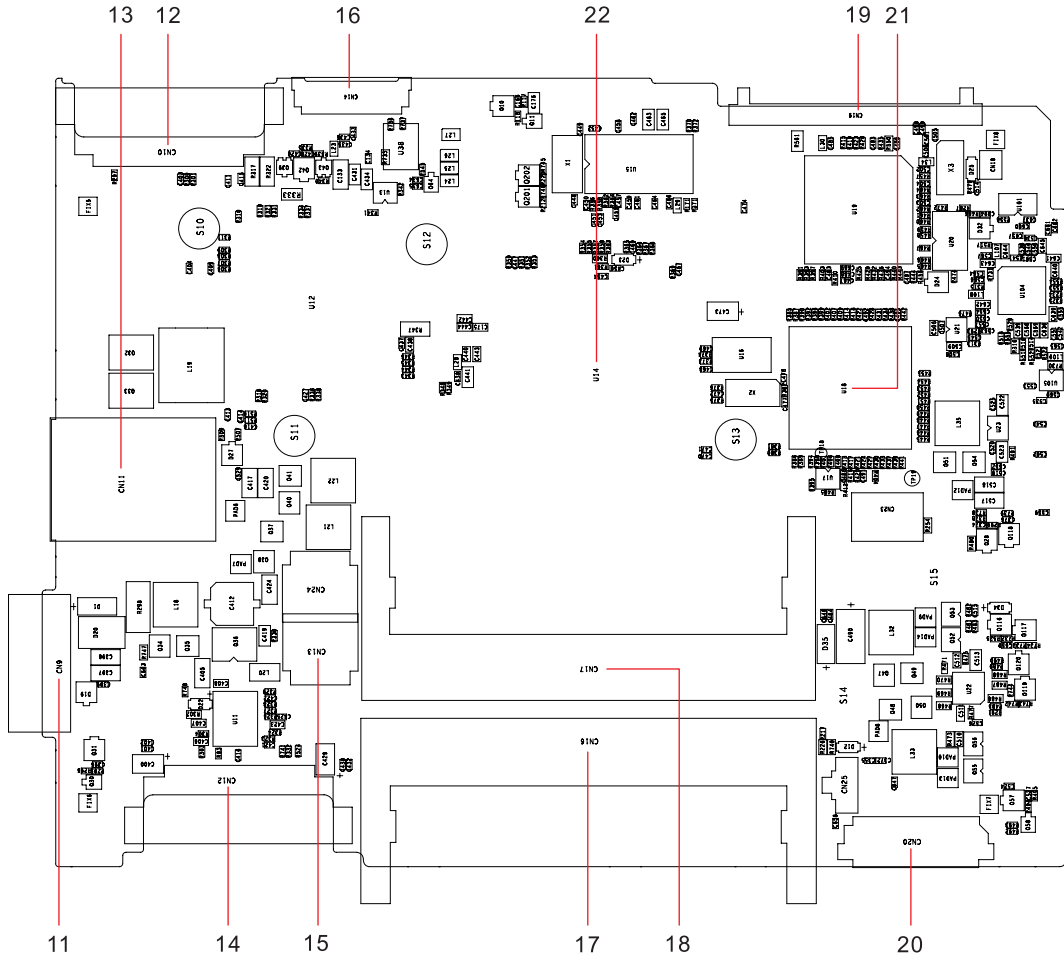

Bottom view		
No.	Name	Description
11	CN9	Battery CNTR
12	CN10	PCI-E socket
13	CN11	SIM card socket
14	CN12	PCI-E socket
15	CN13	Power cable CNTR
16	CN14	LVDS cable CNTR
17	CN16	DIMM socket
18	CN17	DIMM socket
19	CN19	HDD socket
20	CN20	USB board CNTR
21	U18	South Bridge
22	U14	North Bridge

FRU (Field Replaceable Unit) List

This chapter gives you the FRU (Field Replaceable Unit) listing in global configurations of TravelMate 8471/8431. Refer to this chapter whenever ordering for parts to repair or for RMA (Return Merchandise Authorization).

Please note that WHEN ORDERING FRU PARTS, you should check the most up-to-date information available on your regional web or channel. For whatever reasons a part number change is made, it will not be noted on the printed Service Guide. For ACER AUTHORIZED SERVICE PROVIDERS, your Acer office may have a DIFFERENT part number code from those given in the FRU list of this printed Service Guide. You MUST use the local FRU list provided by your regional Acer office to order FRU parts for repair and service of customer machines.

NOTE: To scrap or to return the defective parts, you should follow the local government ordinance or regulations on how to dispose it properly, or follow the rules set by your regional Acer office on how to return it.

TravelMate 8471/8431 Exploded Diagram

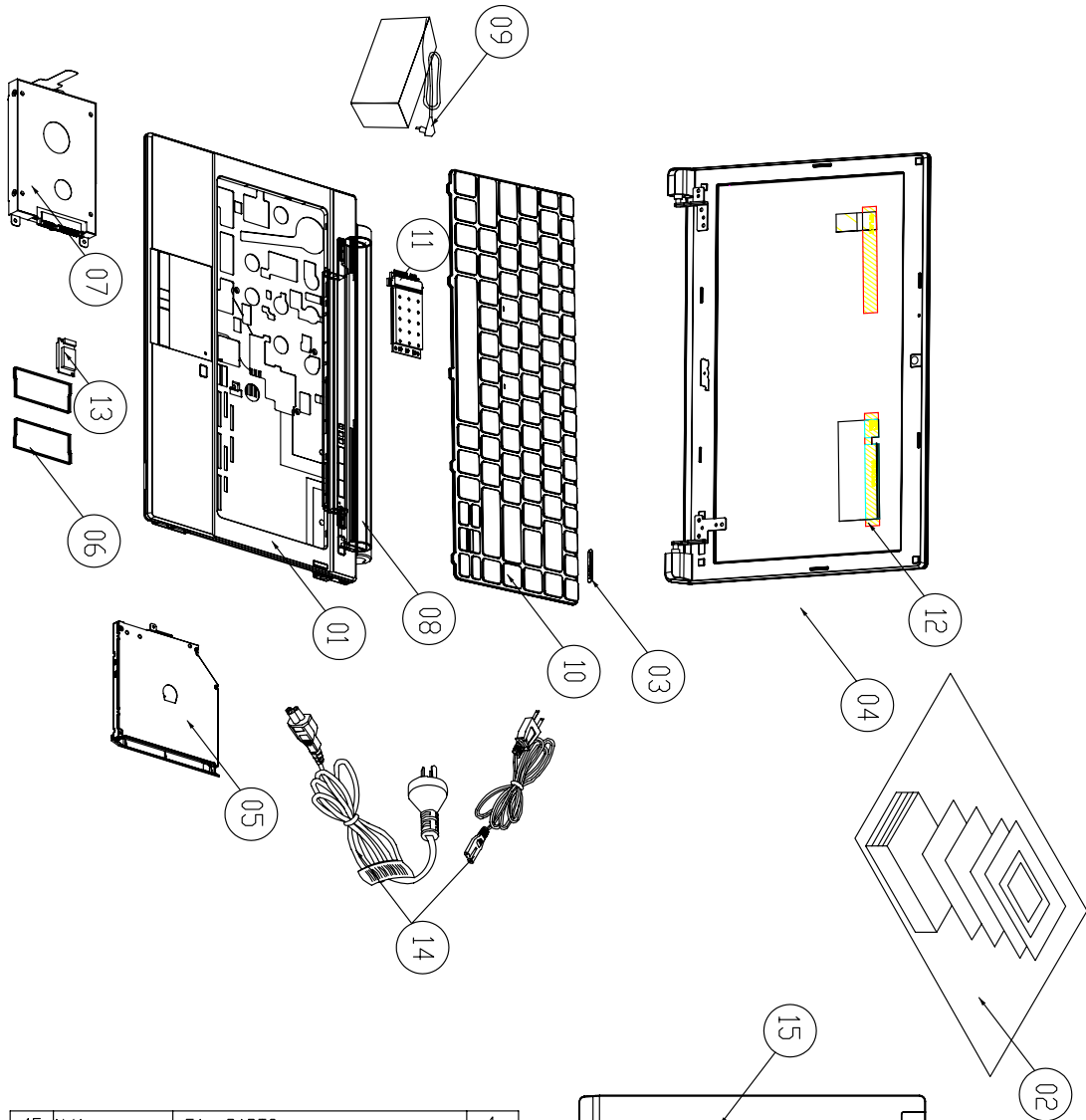

15	N/A	FA PARTS	1
14	6017A0034801	POWER CORD	1
13	1510B0697301	ASSEMBLY,BLUE TOOTH MODULE	1
12	1510B0697101	ASSEMBLY,WIFI	1
11	1510B0764501	ASSEMBLY,3G MODULE	1
10	1510B0729701	ASSEMBLY,KEYBOARD	1
09	6032B0030201	AC ADAPTER	1
08	1510B0696601	ASSEMBLY,BATTERY	1
07	1510B0764901	ASSEMBLY,HDD	1
06	1510B0765101	ASSEMBLY,MEMDRY	1
05	1510B0771601	ASSEMBLY,DDD	1
04	1510B0764201	ASSEMBLY,DISPLAY	1
03	6054B0678403	NAMEPLATE	1
02	1700B0199901	ASSEMBLY,PACKAGING,COUNTRY KIT	1
01	1510B0763501	ASSEMBLY,BASE	1
ITEM	PART NO	DESCRIPTION	Q'TY

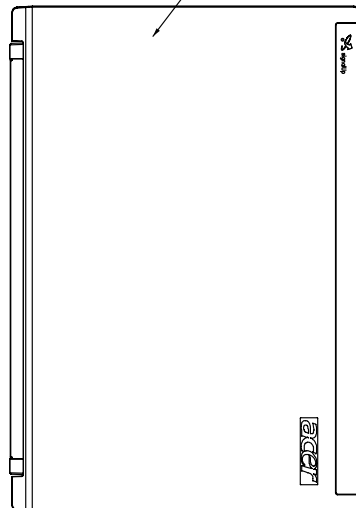

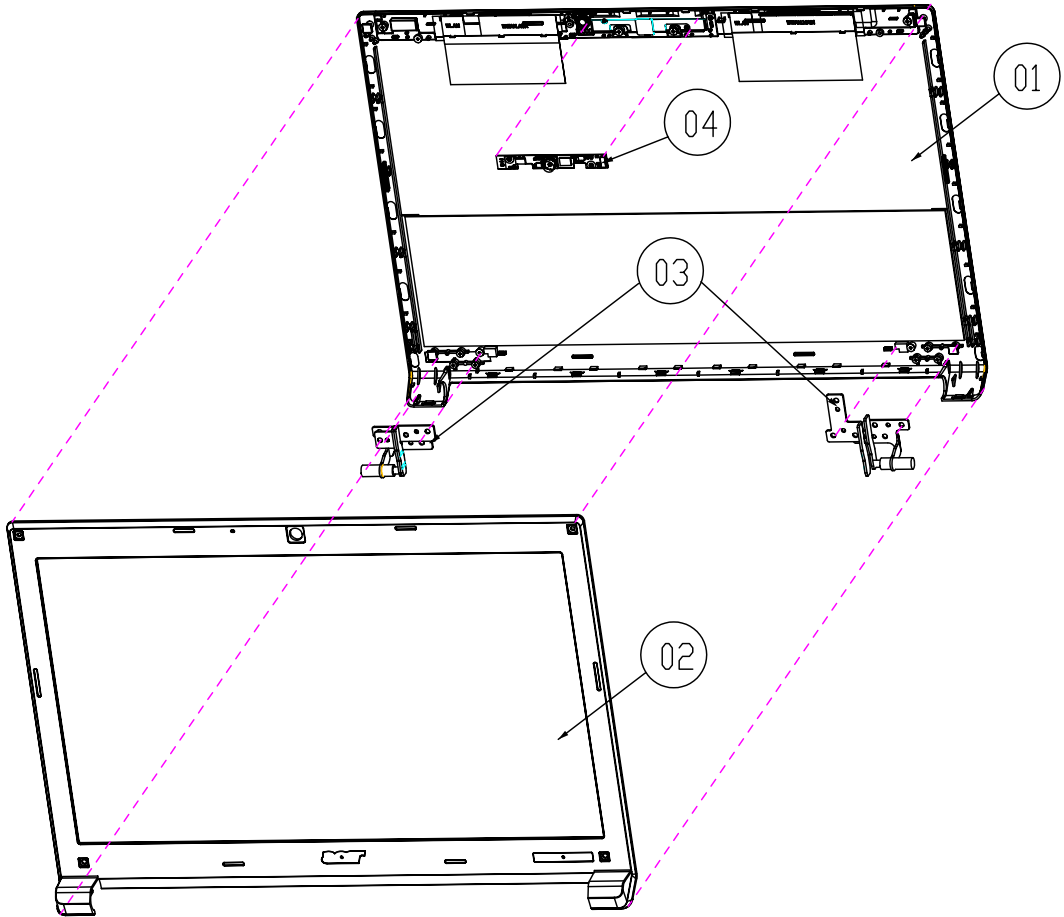

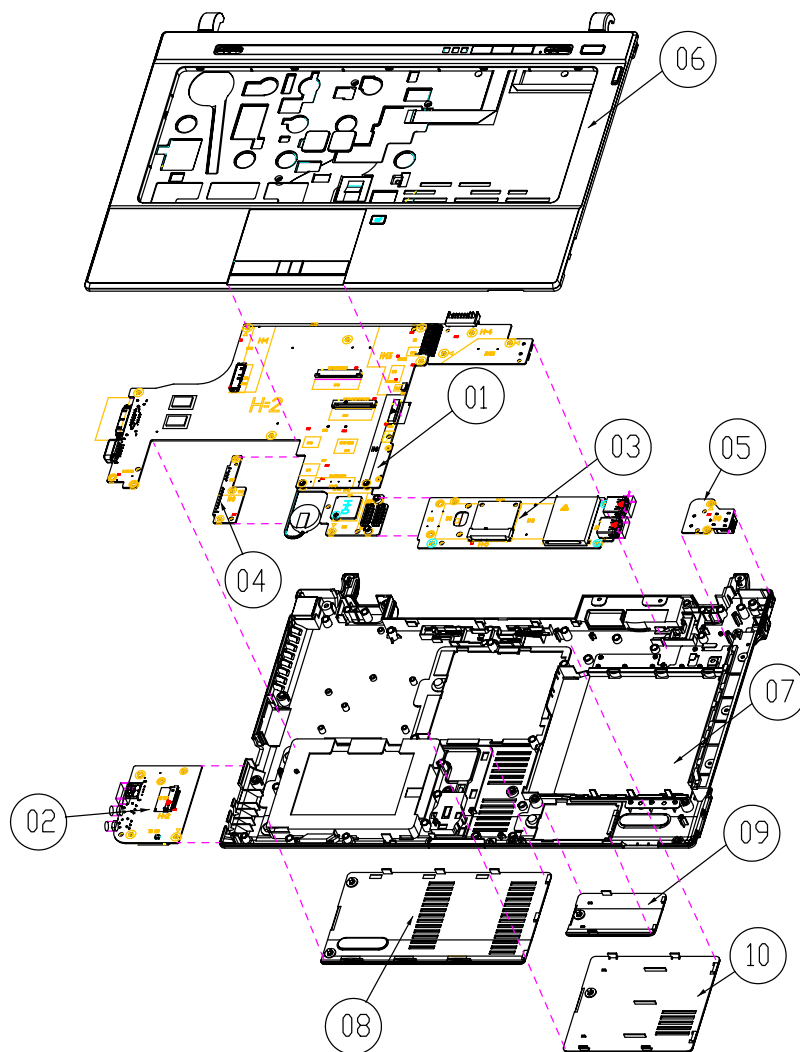

04	6047B0012101	CAMERA MODULE	1
03	1510B0766501	HINGE SET	1
02	1510B0770601	ASSEMBLY,CASE,FRONT,DISPLAY,OFFLINE	1
01	1510B0770701	ASSEMBLY,CASE,REAR,DISPLAY,OFFLINE	1
ITEM	PART NO	DESCRIPTION	Q'TY



10	1510B0770301	ASSEMBLY,CASE,DDR COVER	1
09	1510B0770201	ASSEMBLY,COVER,3G COVER	1
08	1510B0770401	ASSEMBLY,COVER,HDD COVER	1
07	1510B0770801	ASSEMBLY,CASE,BOTTOM	1
06	1510B0765301	ASSEMBLY,CASE,TOP	1
05	1397B0067301	ASSEMBLY,MODULE,DC Jack,OFFLINE	1
04	1397B0067201	ASSEMBLY,MODULE,HDD,OFFLINE	1
03	1397B0067101	ASSEMBLY,MODULE,CARD READER	1
02	1397B0067001	ASSEMBLY,MODULE,AUDIO	1
01	1397A0066701	ASSEMBLY,MODULE,MAIN	1
ITEM	PART NO	DESCRIPTION	Q'TY

TravelMate 8471/8431 FRU List

Accessory

Category	Part Name and Description	Acer Part No.
	WIRELESS ANTENNA LEFT	50.TTP0N.010
	WIRELESS ANTENNA RIGHT	50.TTP0N.011

Adapter

Category	Part Name and Description	Acer Part No.
	ADAPTER DELTA 65W 19V 1.7X5.5X11 YELLOW (ADP-65MH B A) LV5, LF LF	AP.06501.027
	ADAPTER LITE-ON 65W 19V 1.7X5.5X11 YELLOW (PA-1650-22AG), LV5 LF	AP.06503.026
	ADAPTER HIPRO 65W 19V 1.7X5.5X11 YELLOW (HP-A0653R3B 1LF), LV5 LF	AP.0650A.013





Battery

Category	Part Name and Description	Acer Part No.
	Battery SANYO AS-2009D Li-Ion 3S2P SANYO 6 cell 4400mAh	BT.00603.101
	Battery SIMPLO AS-2009D Li-Ion 3S2P PANASONIC 6 cell 4400mAh	BT.00607.109
	Battery SIMPLO AS-2009D Li-Ion 3S2P SAMSUNG 6 cell 4400mAh	BT.00607.110
	Battery SANYO AS-2009D Li-Ion 3S2P SANYO 6 cell 5600mAh	BT.00603.099
	Battery SIMPLO AS-2009D Li-Ion 3S2P SAMSUNG 6 cell 5600mAh	BT.00607.108





Board







Category	Part Name and Description	Acer Part No.
	QUALCOMM 3G MODULE GOBI2000	LC.21300.011
	HUAWEI 3G MODULE EM770W	LC.21300.008

Category	Part Name and Description	Acer Part No.
	LAN INTEL WLAN 512AG_HMWG SHIRLEY PEAK 5100 MM#897072	KI.SPH01.005
	WIRELESS LAN BOARD 512AN_HMWG SHIRLEY PEAK 5100 MM#895373 (HALF MINI-CARD)	KI.SPH01.003
	Foxconn Wireless LAN Atheros HB93 1x2 BGN (HM)	NI.23600.046
	BLUETOOTH BOARD Foxconn BRM 2046 BT2.1 T60H928.33	BH.21100.004
	TOUCH PAD BOARD	55.TTP0N.001
	ODD EJECTION SET	55.TTP0N.002
	TOUCH PAD LOCK SET	55.TTP0N.003
	AUDIO BOARD	55.TTP0N.004
	CARD READER BOARD	55.TTP0N.005
	TRANSFER BOARD	55.TTP0N.006
	HDD TRANSFER BOARD	55.TTX0N.012
	SIM CARD BOARD	55.TTP0N.007

Category	Part Name and Description	Acer Part No.
	DC IN BOARD	55.TTP0N.008
	TOUCH PAD BUTTON BOARD WO/FP	55.TTP0N.009
	TOUCH PAD BUTTON BOARD WO/FP	55.TTP0N.010
	HOTKEY BOARD	55.TTP0N.011

Cable

Category	Part Name and Description	Acer Part No.
	POWER CORD 3PIN USA	27.AAMVN.001
	POWER CORD 3PIN EUR	27.AAMVN.002
	POWER CORD 3PIN SOUTH AFRICA	27.AAMVN.008
	POWER CORD 3PIN DENMARK	27.AAMVN.010
	POWER CORD ISRAEL	27.AAMVN.011
	POWER CORD 3PIN ITALIAN	27.AAMVN.009
	POWER CORD 3PIN UK	27.AAMVN.004
	POWER CORD 3PIN SWISS	27.AAMVN.006
	POWER CORD AUSTRALIA W/LABEL	27.AAMVN.003
	POWER CORD 3PIN CHINA	27.AAMVN.005
	POWER CORD SOUTH AFRICA (AIL)	27.AAMVN.007
	POWER CORD 3PIN TAIWAN	27.APQ0N.001
	AUDIO BOARD CABLE	50.TTP0N.001
	BLUETOOTH CABLE	50.TTP0N.002
	RJ45 CABLE	50.TTP0N.003

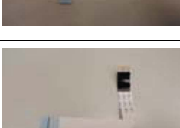
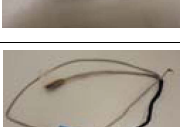





Category	Part Name and Description	Acer Part No.
	SIM CARD BOARD CABLE	50.TTP0N.004
	DC IN BOARD CABLE	50.TTP0N.005
	DC IN BOARD FFC	50.TTP0N.006
	HDD TRANSFER BOARD CABLE	50.TTX0N.010
	TOUCH PAD BUTTON BOARD CABLE 20P	50.TTP0N.007
	TOUCH PAD BUTTON BOARD CABLE 12P	50.TTP0N.008
	HOTKEY BOARD CABLE	50.TTP0N.009
	LCD CABLE W/CCD CABLE	50.TTP0N.012
	LCD CABLE WO/CCD CABLE	50.TTP0N.013

Camera

Category	Part Name and Description	Acer Part No.
	CCD 1.0M SUYIN CN1014-S36D-OV05-R LAVENDER_G	57.PCR0N.001
	CCD MODULE 1.0M CHICONY	57.TTX0N.001

CASE/COVER/BRACKET ASSEMBLY

Category	Part Name and Description	Acer Part No.
	TOUCH PAD BRACKET	60.TTP0N.001
	3G COVER	60.TTP0N.002
	RAM COVER	60.TTP0N.003
	HDD COVER	60.TTP0N.004
	UPPER CASE W/FP	60.TTP0N.005
	UPPER CASE WO/FP	60.TTP0N.006
	LOWER CASE	60.TTP0N.007
	ODD BEZEL	60.TTP0N.008
	ODD BRACKET	60.TTP0N.009
	HDD HOLDER	42.TLK0N.006
	HDD CONNECTOR	20.TLK0N.001

Category	Part Name and Description	Acer Part No.
	LCD COVER 14" W/CCD	60.TTP0N.012
	LCD BEZEL 14" W/CCD	60.TTP0N.013
	LCD COVER 14" WO/CCD	60.TTP0N.014
	LCD BEZEL 14" WO/CCD	60.TTP0N.015
	LCD HINGE R	33.TTP0N.001
	LCD HINGE L	33.TTP0N.002

DVD RW DRIVE

Category	Part Name and Description	Acer Part No.
	ODD TOSHIBA Super-Multi DRIVE 9.5mm Tray DL 8X TS-U633A LF W/O bezel SATA	KU.00801.031
	ODD PANASONIC Super-Multi DRIVE 9.5mm Tray DL 8X UJ892 LF W/O bezel SATA	KU.00807.068
	ODD HLDS Super-Multi DRIVE 9.5mm Tray DL 8X GU10N LF W/O bezel FW:AP03, HF SATA	KU.0080D.046

HDD/SSD

Category	Part Name and Description	Acer Part No.
	HDD 160GB 5400RPM SATA SEAGATE ST9160310AS CORSAIR LF F/W:30303	KH.16001.034
	HDD TOSHIBA 2.5" 5400RPM 160GB MK1655GSX LIBRA SATA LF F/W: FG011J	KH.16004.006
	HDD HGST 2.5" 5400RPM 160GB HTS545016B9A300 PANTHER B SATA LF F/W:C60F	KH.16007.024
	HDD 160GB 5400RPM SATA WD WD1600BEVT-22ZCT0 ML160 LF F/W:11.01A11	KH.16008.022
	HDD SEAGATE 2.5" 5400RPM 250GB ST9250315AS WYATT SATA LF F/W:0001SDM1	KH.25001.016
	HDD TOSHIBA 2.5" 5400RPM 250GB MK2555GSX LIBRA SATA LF F/W:FG001J	KH.25004.003
	HDD HGST 2.5" 5400RPM 250GB HTS545025B9A300 PANTHER B SATA LF F/W:C60F	KH.25007.015
	HDD WD 2.5" 5400RPM 250GB WD2500BEVT-22ZCT0 ML160 SATA LF F/W:11.01A11	KH.25008.021
	HDD 320GB 5400RPM SATA SEAGATE ST9320320AS LF F/W:0303	KH.32001.008
	HDD TOSHIBA 2.5" 5400rpm 320GB MK3263GSX SATA 8MB 68P LF F/W:FG020J	KH.32004.003
	HDD HGST 2.5" 5400RPM 320GB HTS545032B9A300 PANTHER B SATA LF F/W: C60F	KH.32007.007
	HDD 320GB 5400RPM SATA WD WD3200BEVT-22ZCT0 ML160 LF F/W:11.01A11	KH.32008.013
	HDD 500GB 5400RPM SEAGATE ST9500325AS WYATT SATA LF F/W:0001SDM1	KH.50001.011
	HDD TOSHIBA 2.5" 5400RPM 500GB MK5055GSX LIBRA SATA LF F/W:FG001J	KH.50004.001
	HDD HGST 2.5" 5400RPM 500GB HTS545050B9A300 PANTHER B SATA LF F/W:C60F	KH.50007.009
	HDD 500GB 5400RPM WD WD5000BEVT-22ZAT0 ML250 SATA LF F/W:01.01A01	KH.50008.013

HEATSINK

Category	Part Name and Description	Acer Part No.
	THERMAL MODULE UMA	60.TTP0N.010
	THERMAL MODULE DISCRETE	60.TTP0N.011

KEYBOARD

Category	Part Name and Description	Acer Part No.
	Keyboard ACER TM4T BAP31 Internal 14 Standard 88KS Black US International Texture	KB.I140A.167
	Keyboard ACER TM4T BAP31 Internal 14 Standard 88KS Black Arabic Texture	KB.I140A.143
	Keyboard ACER TM4T BAP31 Internal 14 Standard 89KS Black Belgium Texture	KB.I140A.144
	Keyboard ACER TM4T BAP31 Internal 14 Standard 89KS Black Brazilian Portuguese Texture	KB.I140A.145
	Keyboard ACER TM4T BAP31 Internal 14 Standard 89KS Black CZ/SK Texture	KB.I140A.146
	Keyboard ACER TM4T BAP31 Internal 14 Standard 88KS Black Chinese Texture	KB.I140A.147
	Keyboard ACER TM4T BAP31 Internal 14 Standard 89KS Black Danish Texture	KB.I140A.148
	Keyboard ACER TM4T BAP31 Internal 14 Standard 89KS Black FR/Arabic Texture	KB.I140A.149
	Keyboard ACER TM4T BAP31 Internal 14 Standard 89KS Black French Texture	KB.I140A.150
	Keyboard ACER TM4T BAP31 Internal 14 Standard 89KS Black German Texture	KB.I140A.151
	Keyboard ACER TM4T BAP31 Internal 14 Standard 88KS Black Greek Texture	KB.I140A.152
	Keyboard ACER TM4T BAP31 Internal 14 Standard 89KS Black Hungarian Texture	KB.I140A.153
	Keyboard ACER TM4T BAP31 Internal 14 Standard 89KS Black Italian Texture	KB.I140A.154

Category	Part Name and Description	Acer Part No.
	Keyboard ACER TM4T BAP31 Internal 14 Standard 93KS Black Japanese Texture	KB.I140A.155
	Keyboard ACER TM4T BAP31 Internal 14 Standard 89KS Black Nordic Texture	KB.I140A.156
	Keyboard ACER TM4T BAP31 Internal 14 Standard 89KS Black Norwegian Texture	KB.I140A.157
	Keyboard ACER TM4T BAP31 Internal 14 Standard 89KS Black Portuguese Texture	KB.I140A.158
	Keyboard ACER TM4T BAP31 Internal 14 Standard 88KS Black Russian Texture	KB.I140A.159
	Keyboard ACER TM4T BAP31 Internal 14 Standard 89KS Black SLO/CRO Texture	KB.I140A.160
	Keyboard ACER TM4T BAP31 Internal 14 Standard 89KS Black Spanish Texture	KB.I140A.161
	Keyboard ACER TM4T BAP31 Internal 14 Standard 89KS Black Sweden Texture	KB.I140A.162
	Keyboard ACER TM4T BAP31 Internal 14 Standard 89KS Black Swiss/G Texture	KB.I140A.163
	Keyboard ACER TM4T BAP31 Internal 14 Standard 88KS Black Thailand Texture	KB.I140A.164
	Keyboard ACER TM4T BAP31 Internal 14 Standard 89KS Black Turkish Texture	KB.I140A.165
	Keyboard ACER TM4T BAP31 Internal 14 Standard 89KS Black UK Texture	KB.I140A.166
	Keyboard ACER TM4T BAP31 Internal 14 Standard 88KS Black US International w/ Hebrew Texture	KB.I140A.168
	Keyboard ACER TM4T BAP31 Internal 14 Standard 89KS Black US w/ Canadian French Texture	KB.I140A.169

LCD

Category	Part Name and Description	Acer Part No.
	LED LCD AUO 14" WXGA None Glare B140XW02 V3 LF	LK.14005.009
	LED LCD LPL 14" WXGA None Glare LP140WH2-TLB1 LF	LK.14008.003

MIAN BOARD

Category	Part Name and Description	Acer Part No.
	Mainboard TM8471/TM8431 Intel GS45 SU3500 UMA LF	MB.TTP0B.004
	Mainboard TM8471/TM8431 Intel GS45 SU9400 UMA LF	MB.TTP0B.002
	Mainboard TM8471/TM8431 Intel GS45 Celeron 723 UMA LF	MB.TTP0B.005
	Mainboard TM8471G Intel GS45 SU9400 M92LP 512M LF	MB.TTT0B.002
	Mainboard TM8471G Intel GS45 SU3500 M92LP 512M LF	MB.TTT0B.004

MEMORY

Category	Part Name and Description	Acer Part No.
	Memory NANYA SO-DIMM DDRIII 1066 1GB NT1GC64BH8A1PS-BE LF 64*16 0.07um	KN.1GB03.031
	SO-DIMM 1GB DDRIII1066 MICRON MT8JSF12864HY-1G1D1 LF	KN.1GB04.003
	MEMORY SAMSUNG SO-DIMM DDRIII 1066 1GB M471B2873EH1-CF8 LF 64*16 0.055UM	KN.1GB0B.028
	Memory ELPIDA SO-DIMM DDRIII 1066 1GB EBJ11UE6BBS0-AE-F LF 64*16 0.065um	KN.1GB09.011
	Memory ELPIDA SO-DIMM DDRIII 1066 1GB EBJ10UE8BDS0-AE-F LF 128*8 0.065um	KN.1GB09.012
	Memory HYNIX SO-DIMM DDRIII 1066 1GB HMT112S6BFR6C-G7 N0 LF 64*16 0.055um	KN.1GB0G.025
	SO-DIMM 2GB DDRIII1066 MICRON MT16JSF25664HY-1G1D1 LF	KN.2GB04.004
	Memory ELPIDA SO-DIMM DDRIII 1066 2GB EBJ21UE8BBS0-AE-F LF 128*8 0.065um	KN.2GB09.004
	Memory ELPIDA SO-DIMM DDRIII 1066 2GB EBJ21UE8BDS0-AE-F LF 128*8 0.065um	KN.2GB09.006
	MEMORY SAMSUNG SO-DIMM DDRIII 1066 2GB M471B5673EH1-CF8 LF 128*8 0.055UM	KN.2GB0B.012
	Memory HYNIX SO-DIMM DDRIII 1066 2GB HMT125S6BFR8C-G7 N0 LF 128*8 0.055um	KN.2GB0G.014
	Memory NANYA SO-DIMM DDRIII 1066 2GB NT2GC64B8HA1NS-BE LF 128*8 0.07um	KN.2GB03.012

MICROPHONE

Category	Part Name and Description	Acer Part No.
	MICROPHONE	23.TTP0N.001

MISCELLANEOUS

Category	Part Name and Description	Acer Part No.
	HDD INSULATOR	47.TLK0N.005
	LCD BUMPER	47.TTD0N.002
	RUBBER AUDIO	47.TTP0N.001
	RUBBER BOTTOM	47.TTP0N.002
	RUBBER BOTTOM FRONT	47.TTP0N.003

Category	Part Name and Description	Acer Part No.
	RUBBER HINGE CAP	47.TTP0N.004
	NAMEPLATE TM8471	40.TTP0N.001
	NAMEPLATE TM8431	40.TTP0N.002

SCREW

Category	Part Name and Description	Acer Part No.
	SCREW-I25040M PATCH	86.PCR0N.002
	SCREW M4.5*0.8	86.TTX0N.002
	SCREW I M2.5 3MM M 4.5MM 0.8MM NI PATCH	86.AP50N.001
	SCREW M2*3 PATCH	86.PCR0N.005
	SCREW M2.5*9	86.TTP0N.001
	SCREW M2.5*7	86.TTP0N.002
	SCREW M2*3 GROSS	86.TTP0N.003
	SCREW M2*2	86.TTP0N.004

SPEAKER

Category	Part Name and Description	Acer Part No.
	SPEAKER	23.TTP0N.002

